



Product Specification	Model:	AWY-240320T24N04	Rev. No.	Issued Date.	Page.
			B	2013/07/26	1 / 14

Thin Film Transistor LCD MODULE
MODEL: AWY-240320T24N04
Customer's No.:

Acceptance

3504 Lake Lynda Drive, Suite110,
Orlando, FL., USA 32817

Approved and Checked by

Approved by	Checked by		Made by



Revision Record

REV NO.	REV DATE	CONTENTS	Note
A	2013-06-13	NEW ISSUE	
B	2013-07-26	ENHANCED VIEWING ANGLE FROM 20/45/45/45 (D/U/R/L) TO 50/60/60/60 (D/U/R/L)	



Table Of Contents

List	Description	Page No.
	Cover	1
	Revision Record	2
	Table Of Contents	3
1	General Information	4
2	External Dimensions	5
3	Interface Description	6
4	Absolute Maximum Ratings	7
5	DC Characteristics	7
6	Timing Characteristics	7
7	Backlight Characteristics	8
8	Optical Characteristics	9
9	Reliability Test Conditions And Methods	11
10	Inspection Standard	12
11	Handling Precautions	13
12	Precaution For Use	14



1. General Information

ITEM	STANDARD VALUES	UNITS
LCD type	2.4" TFT	--
Dot arrangement	240(RGB)×320	dots
Color filter array	RGB vertical stripe	--
Display mode	TN / Transmissive / Normally White	--
Viewing Direction	12 o'clock	--
Driver IC	ILI9341	--
Module size	42.72(W)×60.26(H)×2.3(T)	mm
Active area	36.72(W)×48.96(H)	mm
Dot pitch	0.153 (W)×0.153 (H)	mm
Interface	i80-system 8/16-bit interface	
Operating temperature	-20 ~ +70	°C
Storage temperature	-30 ~ +80	°C
Back Light	4 White LED In Parallel	--
Weight	TBD	g



2. External Dimensions

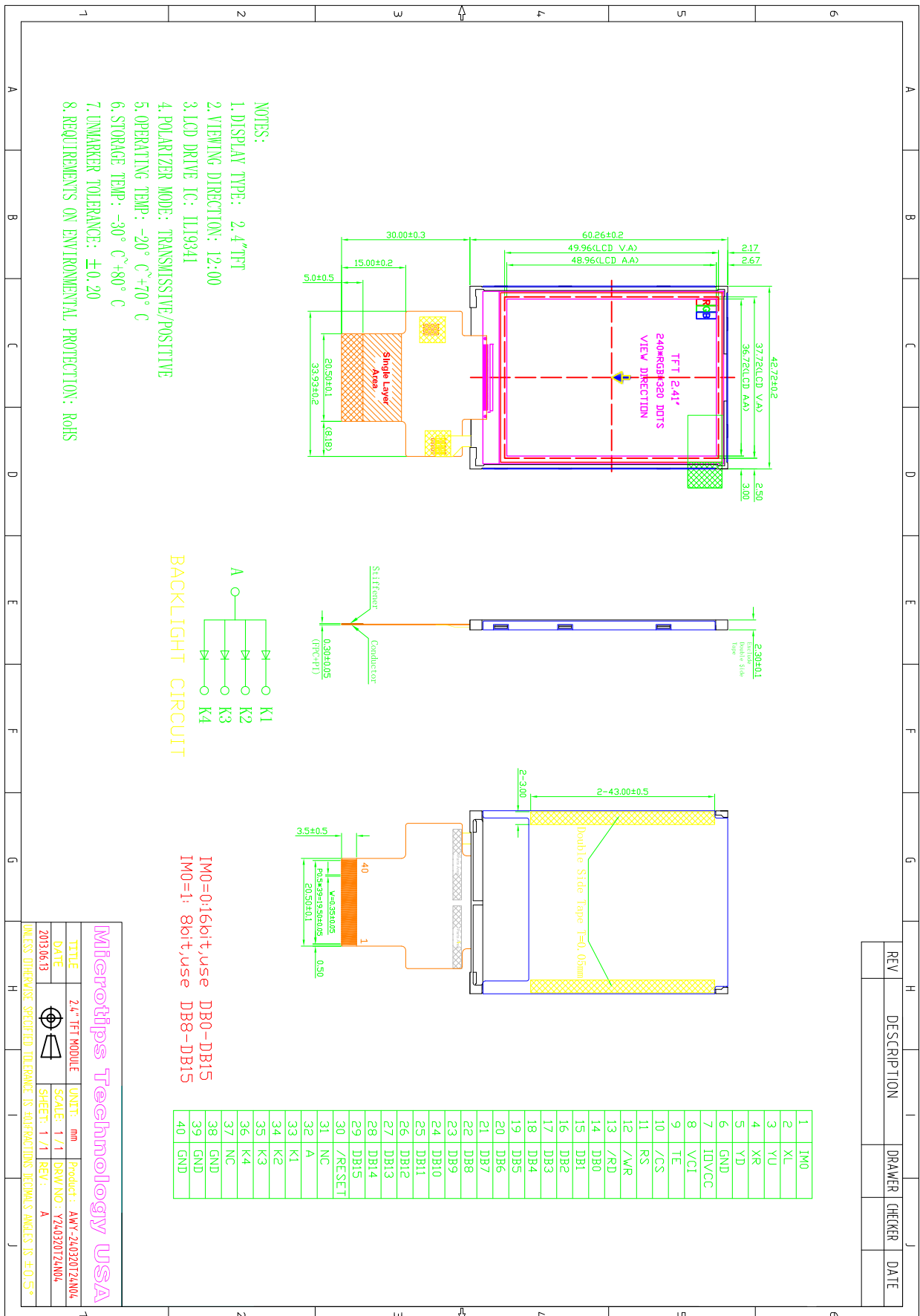



3. Interface Description

PIN NO.	PIN NAME	DESCRIPTION
1	IM0	IM0=0:16bit,use DB0-DB15. IM0=1: 8bit,use DB8-DB15.
2	XL	TOUCH PIN.(NC)
3	YU	
4	XR	
5	YD	
6	GND	
7	IOVCC	System power supply (1.8V or 2.8V).
8	VCI	System power supply (2.8V).
9	TE	Tearing effect output pin to synchronize MPU to frame writing, activated by S/W command.
10	/CS	Chip select signal input terminal, Active at 'L'
11	RS	Register select signal input terminal: RS='H': select a control register; RS='L': select an index or status register.
12	/WR	Write signal input terminal, Active at 'L'
13	/RD	Read signal input terminal, Active at 'L'.
14	DB0	DATA BUS: 8-bit I/F: DB[15:8] is used. 16-bit I/F: DB[15:0] is used. Unused pins must be fixed to GND level.
15	DB1	
16	DB2	
17	DB3	
18	DB4	
19	DB5	
20	DB6	
21	DB7	
22	DB8	
23	DB9	
24	DB10	
25	DB11	
26	DB12	
27	DB13	
28	DB14	
29	DB15	
30	/RESET	Reset signal input terminal, active at 'L'
31	NC	NC
32	LED-A	LED backlight anode
33	LED-K1	LED backlight kathode
34	LED-K2	LED backlight kathode
35	LED-K3	LED backlight kathode
36	LED-K4	LED backlight kathode
37	NC	NC
38	GND	Power ground
39	GND	Power ground
40	GND	Power ground



4. Absolute Maximum Ratings

Item	Symbol	Min.	Max.	Unit
Logic Supply Voltage	IOVCC	-0.3	4.6	V
Analog Supply Voltage	VCC	-0.3	4.6	V
Input Voltage	V _{in}	-0.3	IOVCC+0.3	V
Operating Temperature	T _{OP}	-20	70	°C
Storage Temperature	T _{ST}	-30	80	°C
Storage Humidity	HD	20	90	%RH

5. DC Characteristics

Item	Symbol	Min.	Typ.	Max.	Unit	Remark
Logic Supply Voltage	IOVCC	1.65	1.8/2.8	3.3	V	-
Analog Supply Voltage	VCC	2.5	2.8	3.3	V	-
Input High Voltage	V _{IH}	0.7IOVCC	-	IOVCC	V	Digital input pins
Input Low Voltage	V _{IL}	GND	-	0.3IOVCC	V	Digital input pins
Output High Voltage	V _{OH}	0.8IOVCC	-	IOVCC	V	Digital output pins
Output Low Voltage	V _{OL}	GND	-	0.2IOVCC	V	Digital output pins
I/O Leak Current	I _{LI}	-0.1	-	0.1	uA	-

6. Timing Characteristics

6.1 i80-System Interface Timing Characteristics

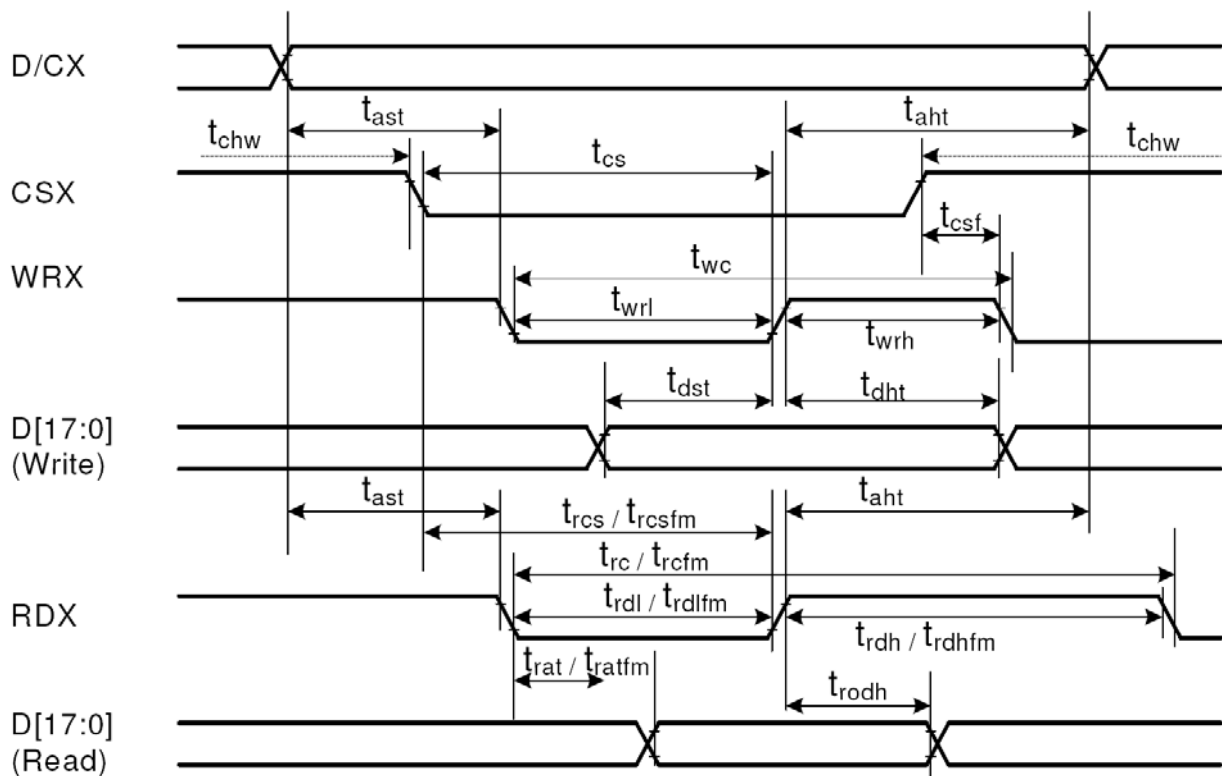



Signal	Symbol	Parameter	min	max	Unit	Description
DCX	tast	Address setup time	0	-	ns	
	taht	Address hold time (Write/Read)	0	-	ns	
CSX	tchw	CSX "H" pulse width	0	-	ns	
	tcs	Chip Select setup time (Write)	15	-	ns	
	trcs	Chip Select setup time (Read ID)	45	-	ns	
	trcsfm	Chip Select setup time (Read FM)	355	-	ns	
	tcsf	Chip Select Wait time (Write/Read)	10	-	ns	
WRX	twc	Write cycle	66	-	ns	
	twrh	Write Control pulse H duration	15	-	ns	
	twrl	Write Control pulse L duration	15	-	ns	
RDX (FM)	trcfm	Read Cycle (FM)	450	-	ns	
	trdhfm	Read Control H duration (FM)	90	-	ns	
	trdlfm	Read Control L duration (FM)	355	-	ns	
RDX (ID)	trc	Read cycle (ID)	160	-	ns	
	trdh	Read Control pulse H duration	90	-	ns	
	trdl	Read Control pulse L duration	45	-	ns	
D[17:0], D[17:10]&D[8:1], D[17:10], D[17:9]	tdst	Write data setup time	10	-	ns	For maximum CL=30pF For minimum CL=8pF
	tdht	Write data hold time	10	-	ns	
	trat	Read access time	-	40	ns	
	tratfm	Read access time	-	340	ns	
	trod	Read output disable time	20	80	ns	

6.2 Reset Timing Characteristics

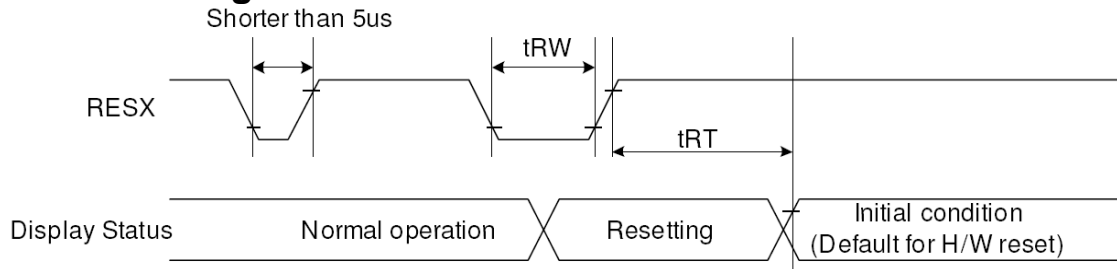

Signal	Symbol	Parameter	Min	Max	Unit
RESX	t_{RW}	Reset pulse duration	10		uS
	t_{RT}	Reset cancel		5 (note 1,5)	mS
				120 (note 1.6,7)	mS

7. Backlight Characteristics

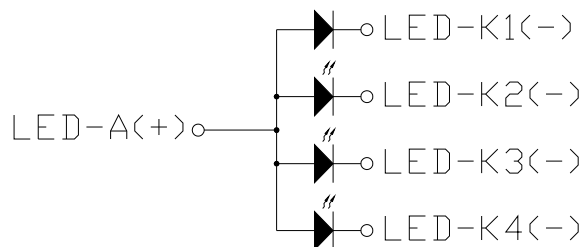

Item	Symbol	MIN	TYP	MAX	UNIT	Test Condition
Supply Voltage	Vf	3.0	3.2	3.5	V	If=60mA
Supply Current	If	-	60	80	mA	-
Luminous Intensity for LCM	-	200	250	-	cd/m ²	If=60mA
Uniformity for LCM	-	80	-	-	%	If=60mA
Life Time	-	20000	-	-	Hr	If=60mA
Backlight Color		White				



8. Optical Characteristics

Item	Symbol	Condition	Min.	Typ.	Max.	Unit	Note
Transmittance (without Polarizer)	T(%)	—	—	(14.4)	—	—	
Contrast Ratio	CR	$\theta=0$	400	500	—	—	(1)(2)
Response time	Rising	T_R	—	4	8	msec	(1)(3)
	Falling	T_F	—	12	24		
Color gamut	S(%)			60		%	
Color chromaticity (CIE1931)	White	W_x		0.283	0.303	0.323	(1)(4) CF glass (C-light)
		W_y		0.305	0.325	0.345	
	Red	R_x		0.606	0.626	0.646	
		R_y		0.314	0.334	0.354	
	Green	G_x		0.257	0.277	0.297	
		G_y		0.529	0.549	0.569	
	Blue	B_x		0.122	0.142	0.162	
		B_y		0.102	0.122	0.142	
Viewing angle	Hor.	θ_L	CR>10	50	60	—	
		θ_R		50	60	—	
	Ver.	θ_U		50	60	—	
		θ_D		40	50	—	
Optima View Direction	12 O'clock						(5)

Measuring Condition:

Dark room, $25\pm 2^\circ\text{C}$ 15min. warm-up time.

Measuring Equipment

FPM520 of Westar Display technologies, INC., which utilized SR-3 for Chromaticity and BM-5A for other optical characteristics.

Note (1) Definition of Viewing Angle :

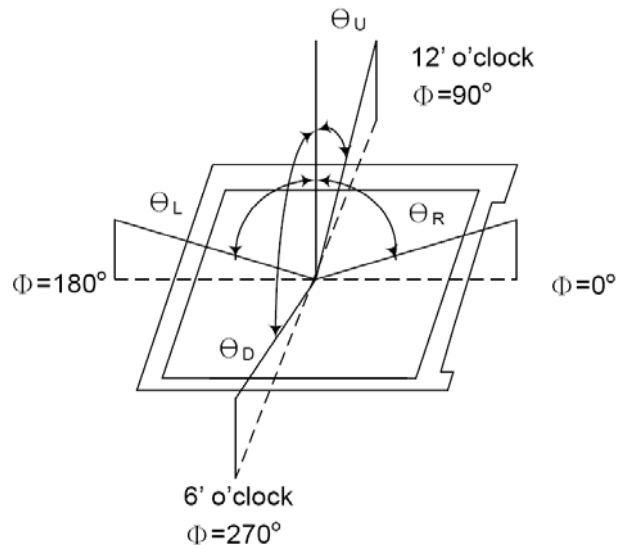

Note (2) Definition of Contrast Ratio(CR) :

Microtips Technology USA

3504 Lake Lynda Drive, Suite 110, Orlando, FL., USA 32817



Measured at the center point of panel

CR = Luminance with all pixels white / Luminance with all pixels black

Note (3) Definition of Response Time : Sum of TR and TF

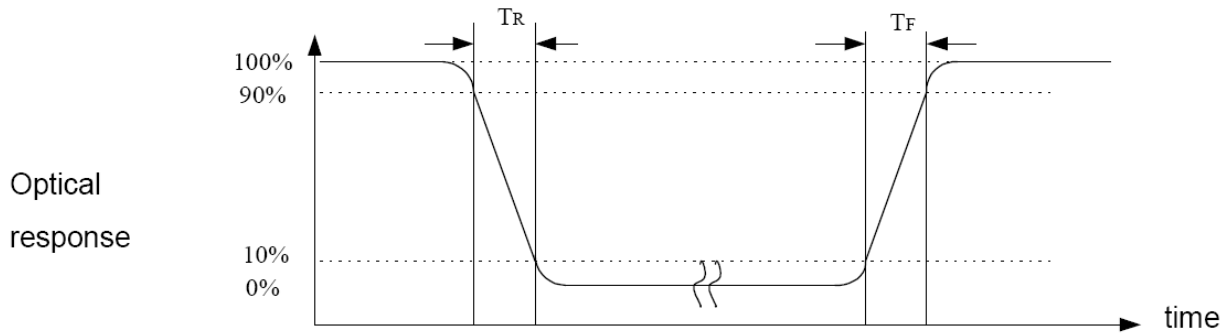
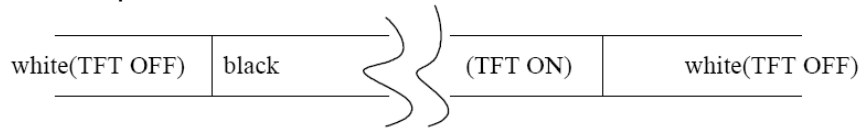

Note (4) Definition of optical measurement setup

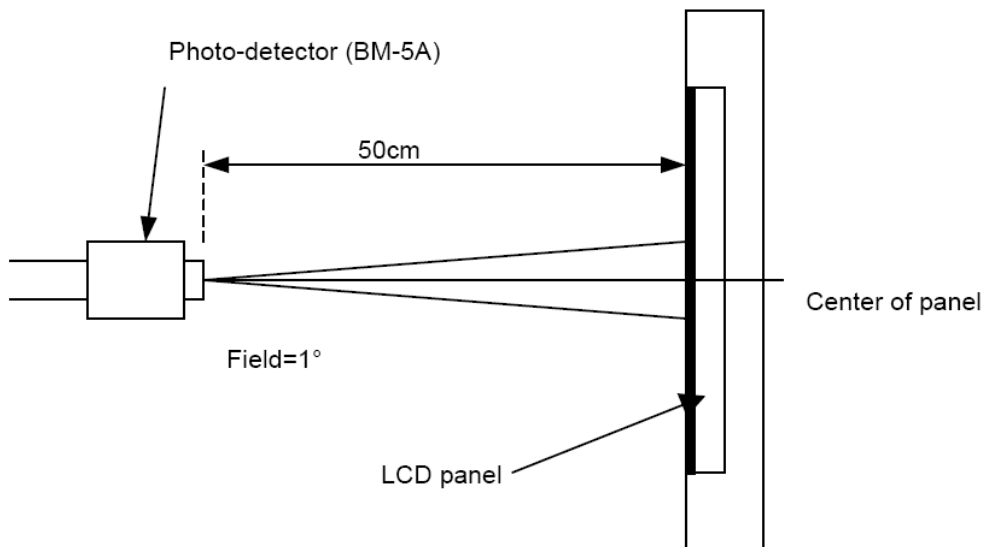

Note (5) Rubbing Direction (The different Rubbing Direction will cause the different optima view direction). TFT Face UP

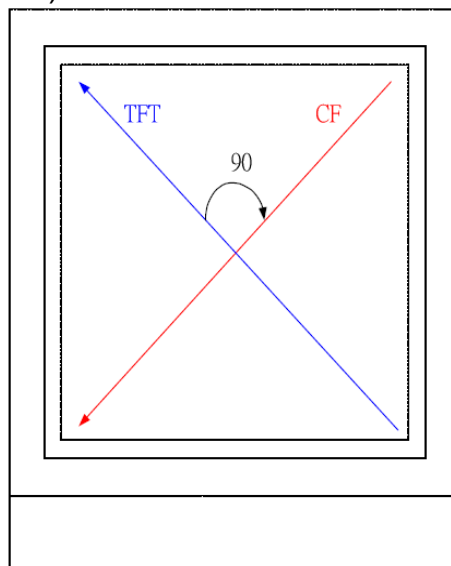



9. Reliability Test Conditions And Methods

NO.	TEST ITEMS	TEST CONDITION	INSPECTION AFTER TEST
①	High Temperature Storage	80°C±2°C×200Hours	Inspection after 2~4hours storage at room temperature, the samples should be free from defects: 1,Air bubble in the LCD. 2,Sealleak. 3,Non-display. 4,Missing segments. 5,Glass crack. 6,Current IDD is twice higher than initial value. 7,The surface shall be free from damage. 8,The electric characteristic requirements shall be satisfied.
②	Low Temperature Storage	-30°C±2°C×200Hours	
③	High Temperature Operating	70°C±2°C×120Hours	
④	Low Temperature Operating	-20°C±2°C×120Hours	
⑤	Temperature Cycle(Storage)	-20°C ↔ 25°C ↔ 70°C (30min) (5min) (30min) 1cycle Total 10cycle	
⑥	Damp Proof Test (Storage)	50°C±5°C×90%RH×120Hours	
⑦	Vibration Test	Frequency:10Hz~55Hz~10Hz Amplitude:1.5M X,Y,Z direction for total 3hours (Packing Condition)	
⑧	Drooping Test	Drop to the ground from 1M height one time every side of carton. (Packing Condition)	
⑨	ESD Test	Voltage:±8KV,R:330Ω,C:150PF,Air Mode,10times	

REMARK:

- 1,The Test samples should be applied to only one test item.
- 2,Sample side for each test item is 5~10pcs.
- 3,For Damp Proof Test, Pure water(Resistance > 10MΩ)should be used.
- 4,In case of malfunction defect caused by ESD damage, if it would be recovered to normal state after resetting, it would be judge as a good part.
- 5,EL evaluation should be excepted from reliability test with humidity and temperature: Some defects such as black spot/blemish can happen by natural chemical reaction with humidity and Fluorescence EL has.
- 6,Failure Judgment Criterion: Basic Specification Electrical Characteristic, Mechanical Characteristic, Optical Characteristic.



10. Inspection Standard

This standard apply to TFT module specification.

1. Inspection condition:

Under daylight lamp 20~40W, product distance inspector'eye 30cm,incline degree 30° 。

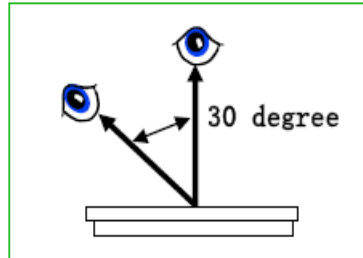

2. Inspection standard

NO.	Item	Inspection standard	Rate															
2.1	Dot	<p>Case of Dot defect is below</p> <p>① Bright Dot (whit spot) : "0"</p> <p>② Dark Dot (black spot) : "0" (In case of Dark Dot on Main TFT LCD)</p> <p>- NG if there's full Dot defect.</p> <p>- Damaged less than the size of sub-pixel is not counted as defect</p> <p>- Dots darker than the size of sub-pixel are not defined as bright dot defect</p> <table border="1" style="width: 100%; border-collapse: collapse;"> <thead> <tr> <th style="text-align: center;">area size (mm)</th> <th style="text-align: center;">Acceptable number</th> </tr> </thead> <tbody> <tr> <td style="text-align: center;">$\Phi \leq 0.10$</td> <td style="text-align: center;">ignore</td> </tr> <tr> <td style="text-align: center;">$0.10 < \Phi \leq 0.15$</td> <td style="text-align: center;">3</td> </tr> <tr> <td style="text-align: center;">$0.15 < \Phi \leq 0.20$</td> <td style="text-align: center;">2</td> </tr> <tr> <td style="text-align: center;">$0.25 < \Phi \leq 0.25$</td> <td style="text-align: center;">1</td> </tr> <tr> <td style="text-align: center;">$0.25 < \Phi$</td> <td style="text-align: center;">0</td> </tr> </tbody> </table>	area size (mm)	Acceptable number	$\Phi \leq 0.10$	ignore	$0.10 < \Phi \leq 0.15$	3	$0.15 < \Phi \leq 0.20$	2	$0.25 < \Phi \leq 0.25$	1	$0.25 < \Phi$	0	minor			
area size (mm)	Acceptable number																	
$\Phi \leq 0.10$	ignore																	
$0.10 < \Phi \leq 0.15$	3																	
$0.15 < \Phi \leq 0.20$	2																	
$0.25 < \Phi \leq 0.25$	1																	
$0.25 < \Phi$	0																	
2.2	line	<table border="1" style="width: 100%; border-collapse: collapse;"> <thead> <tr> <th colspan="2" style="text-align: center;">Size (mm)</th> <th style="text-align: center;">Acceptable number</th> </tr> </thead> <tbody> <tr> <td style="text-align: center;">ignore</td> <td style="text-align: center;">$W \leq 0.03$</td> <td style="text-align: center;">ignore</td> </tr> <tr> <td style="text-align: center;">$L \leq 4.0$</td> <td style="text-align: center;">$0.03 < W \leq 0.04$</td> <td style="text-align: center;">2</td> </tr> <tr> <td style="text-align: center;">$L \leq 4.0$</td> <td style="text-align: center;">$0.04 < W \leq 0.05$</td> <td style="text-align: center;">1</td> </tr> <tr> <td></td> <td style="text-align: center;">$0.05 < W$</td> <td style="text-align: center;">Treat with dot non-conformance</td> </tr> </tbody> </table>	Size (mm)		Acceptable number	ignore	$W \leq 0.03$	ignore	$L \leq 4.0$	$0.03 < W \leq 0.04$	2	$L \leq 4.0$	$0.04 < W \leq 0.05$	1		$0.05 < W$	Treat with dot non-conformance	
Size (mm)		Acceptable number																
ignore	$W \leq 0.03$	ignore																
$L \leq 4.0$	$0.03 < W \leq 0.04$	2																
$L \leq 4.0$	$0.04 < W \leq 0.05$	1																
	$0.05 < W$	Treat with dot non-conformance																



11. Handling Precautions

11.1 Mounting method

The LCD panel of SC LCD module consists of two thin glass plates with polarizers which easily be damaged. And since the module is so constructed as to be fixed by utilizing fitting holes in the printed circuit board.

Extreme care should be needed when handling the LCD modules.

11.2 Caution of LCD handling and cleaning

When cleaning the display surface, Use soft cloth with solvent [recommended below] and wipe lightly

- Isopropyl alcohol
- Ethyl alcohol

Do not wipe the display surface with dry or hard materials that will damage the polarizer surface.

Do not use the following solvent:

- Water
- Aromatics

Do not wipe ITO pad area with the dry or hard materials that will damage the ITO patterns

Do not use the following solvent on the pad or prevent it from being contaminated:

- Soldering flux
- Chlorine (Cl) , Sulfur (S)

If goods were sent without being silicon coated on the pad, ITO patterns could be damaged due to the corrosion as time goes on.

If ITO corrosion happens by miss-handling or using some materials such as Chlorine (Cl), Sulfur (S) from customer, Responsibility is on customer.

11.3 Caution against static charge

The LCD module use C-MOS LSI drivers, so we recommended that you:

Connect any unused input terminal to Vdd or Vss, do not input any signals before power is turned on, and ground your body, work/assembly areas, assembly equipment to protect against static electricity.

11.4 packing

- Module employ LCD elements and must be treated as such.
- Avoid intense shock and falls from a height.
- To prevent modules from degradation, do not operate or store them exposed direct to sunshine or high temperature/humidity

11.5 Caution for operation

- It is an indispensable condition to drive LCD's within the specified voltage limit since the higher voltage than the limit cause the shorter LCD life.
- An electrochemical reaction due to direct current causes LCD's undesirable deterioration, so that the use of direct current drive should be avoided.
- Response time will be extremely delayed at lower temperature than the operating temperature range and on the other hand at higher temperature LCD's show dark color in them. However those phenomena do not mean malfunction or out of order with LCD's, which will come back in the specified operation temperature.
- If the display area is pushed hard during operation, some font will be abnormally displayed but it resumes normal condition after turning off once.
- A slight dew depositing on terminals is a cause for electro-chemical reaction resulting in terminal open circuit.

Usage under the maximum operating temperature, 50%Rh or less is required.



11.6 storage

In the case of storing for a long period of time for instance, for years for the purpose or replacement use, the following ways are recommended.

- Storage in a polyethylene bag with the opening sealed so as not to enter fresh air outside in it .
And with no desiccant.
- Placing in a dark place where neither exposure to direct sunlight nor light's keeping the storage temperature range.
- Storing with no touch on polarizer surface by the anything else.
[It is recommended to store them as they have been contained in the inner container at the time of delivery from us

11.7 Safety

- It is recommendable to crash damaged or unnecessary LCD's into pieces and wash off liquid crystal by either of solvents such as acetone and ethanol, which should be burned up later.
- When any liquid leaked out of a damaged glass cell comes in contact with your hands, please wash it off well with soap and water

12. Precaution For Use

12.1

A limit sample should be provided by the both parties on an occasion when the both parties agreed its necessity. Judgment by a limit sample shall take effect after the limit sample has been established and confirmed by the both parties.

12.2

On the following occasions, the handing of problem should be decided through discussion and agreement between responsible of the both parties.

- When a question is arisen in this specification
- When a new problem is arisen which is not specified in this specifications
- When an inspection specifications change or operating condition change in customer is reported to GT LCD , and some problem is arisen in this specification due to the change
- When a new problem is arisen at the customer's operating set for sample evaluation in the customer site.