





Messrs.					
Product Specification	Model:	MTF-TQ57SN741-AV	Rev. No.	Issued Date.	Page.
			B	Jan. 17, 08	1 / 28

LIQUID CRYSTAL DISPLAY MODULE
MODEL: MTF-TQ57SN741-AV
Customer's No.:

Acceptance

Microtips Technology Inc.
 12F. No.31 Lane 169, Kang Ning St.,
 His-Chih, Taipei Hsien, Taiwan
 FAX: 886-2-26958625

Approved and Checked by

Approved by	Checked by		Made by
			



Microtips Technology Inc.

Messrs.					
Product Specification	Model:	MTF-TQ57SN741-AV	Rev. No.	Issued Date.	Page.
			B	Jan. 17, 08	2 / 28

Revise Records

Rev.	Date	Contents	Written	Approved
A	2007/12/14	Specification released	Sherry Chen	Steele Lee
B	2008/01/17	See Note 1	Sherry Chen	Steele Lee

Special Notes

Note1.	Del 8080 8bit interface Timing (write cycle) and 8080 8bit interface Timing (read cycle) (Page15~16)
Note2.	
Note3.	
Note4.	
Note5.	



Messrs.					
Product Specification	Model:	MTF-TQ57SN741-AV	Rev. No.	Issued Date.	Page.
			<i>B</i>	<i>Jan. 17, 08</i>	<i>3 / 28</i>

Contents

1. GENERAL DESCRIPTION AND FEATURES	4
1.1 Features	4
1.2 General Specifications	4
2. INPUT TERMINAL PIN ASSIGNMENT	5
2.1 Pin Assignment	5
2.2 Back-light Unit (BLU)	5
3. BLOCK DIAGRAM	6
4. OPTICAL CHARACTERISTICS	7
5. ABSOLUTE MAXIMUM RATINGS	10
5.1 Absolute Ratings of Environment	10
5.2 Electrical Absolute Maximum Rating	11
6. 8080 INDIRECT ADDRESSING MODE	12
6.1 8080 16 bit interface Timing (write cycle)	12
6.2 8080 16 bit interface Timing (read cycle)	13
6.3 8080 indirect interface Timing	14
7. ELECTRICAL CHARACTERISTICS	15
7.1 DC Electrical Characteristics	15
8. BACKLIGHT SPECIFICATIONS	16
9. DISPLAYED COLOR AND INPUT DATA	17
10. QUALITY STANDARD FOR LCD	18
10.1 Objective	18
10.2 Scope	18
10.3 Inspection specification	20
11. RELIABILITY CONDITION	23
12. PRECAUTIONS	24
12.1 Operation	24
12.2 Safety	24
12.3 Handling	24
12.4 Static electricity	26
12.5 Storage	26
12.6 Cleaning	26
12.7 Waste	26
13. WARRANTY	27
14. DIMENSIONAL OUTLINES	27



Messrs.					
Product Specification	Model:	MTF-TQ57SN741-AV	Rev. No.	Issued Date.	Page.
			B	Jan. 17, 08	4 / 28

1. GENERAL DESCRIPTION AND FEATURES

MTF-TQ57SN741-AV is a TM (Transmissive) type color active matrix TFT (Thin Film Transistor) liquid crystal display (LCD) that uses amorphous silicon TFT as a switching device. This model is composed of a TFT-LCD module, a driver circuit and a back-light unit. The resolution of a 5.7" contains 320RGB×240 dots and can display up to 262K colors. The following table described the features of MTF-TQ57SN741-AV.

1.1 Features

- Transmissive type with LED back-light.
- TN (Twisted Nematic) mode.
- Backlight-driving DC/AC inverter is not built in this module.

1.2 General Specifications

Item	Specification	Unit
Screen Size	5.7 inches diagonal	-
Display Resolution	320 x RGB x 240	Dot
Pixel Pitch	0.36 (H) × 0.36 (V)	mm
Active Area	115.2 (W) x 86.4 (H)	mm
Outline Dimension	144.0 (W) x 104.6 (H) x 12.8 (T), without FPCB tail.	mm
Weight	155g (MTF-TQ57SN741-AV)	--
	202g (MTF-TQ57SP741-AV)	
Display Mode	Normally white/Transmissive/Wide view	--
Pixel Arrangement	RGB-Vertical Stripe	--
Surface Treatment	Non-glare (3H)	--
Viewing Direction	6 o'clock	-
Input Interface	16-bit high-speed bus interface (Intel 80 series)	--
Color Garmut	NTSC 58%	--



Messrs.					
Product Specification	Model:	MTF-TQ57SN741-AV	Rev. No.	Issued Date.	Page.
			B	Jan. 17, 08	5 / 28

2. INPUT TERMINAL PIN ASSIGNMENT

2.1 Pin Assignment

Pin No.	Symbol	I/O	Function	Remark
1	GND	I	GND	--
2	V _{DD}	--	+ 3.3V power supply	--
3	WR#	I	VRAM write signal	--
4	RD#	I	VRAM read signal	--
5	CS#	I	Chip Select	--
6	NC	--	No Connection	--
7	REST#	I	Reset	--
8	D/C#	I	Register Select Signal; H: Data, Low: Command	--
9	DB15	I	Display data	--
10	DB14	I	Display data	--
11	DB13	I	Display data	--
12	DB12	--	Display data	--
13	DB11	I	Display data	--
14	DB10	I	Display data	--
15	DB9	I	Display data	--
16	DB8	I	Display data	--
17	DB7	I	Display data	--
18	DB6	I	Display data	--
19	DB5	--	Display data	--
20	DB4	I	Display data	--
21	DB3	I	Display data	--
22	DB2	I	Display data	--
23	DB1	I	Display data	--
24	DB0	I	Display data	--
25	V _{DD}	--	+ 3.3V power supply	--
26	GND	--	GND	--

2.2 Back-light Unit (BLU)

Pin No.	Symbol	Function	Remark
1	LEDA	Power Supply for LED backlight	--
2	LEDK	GND for LED backlight	--



Messrs.					
Product Specification	Model:	MTF-TQ57SN741-AV	Rev. No.	Issued Date.	Page.
			B	Jan. 17, 08	6 / 28

3. BLOCK DIAGRAM

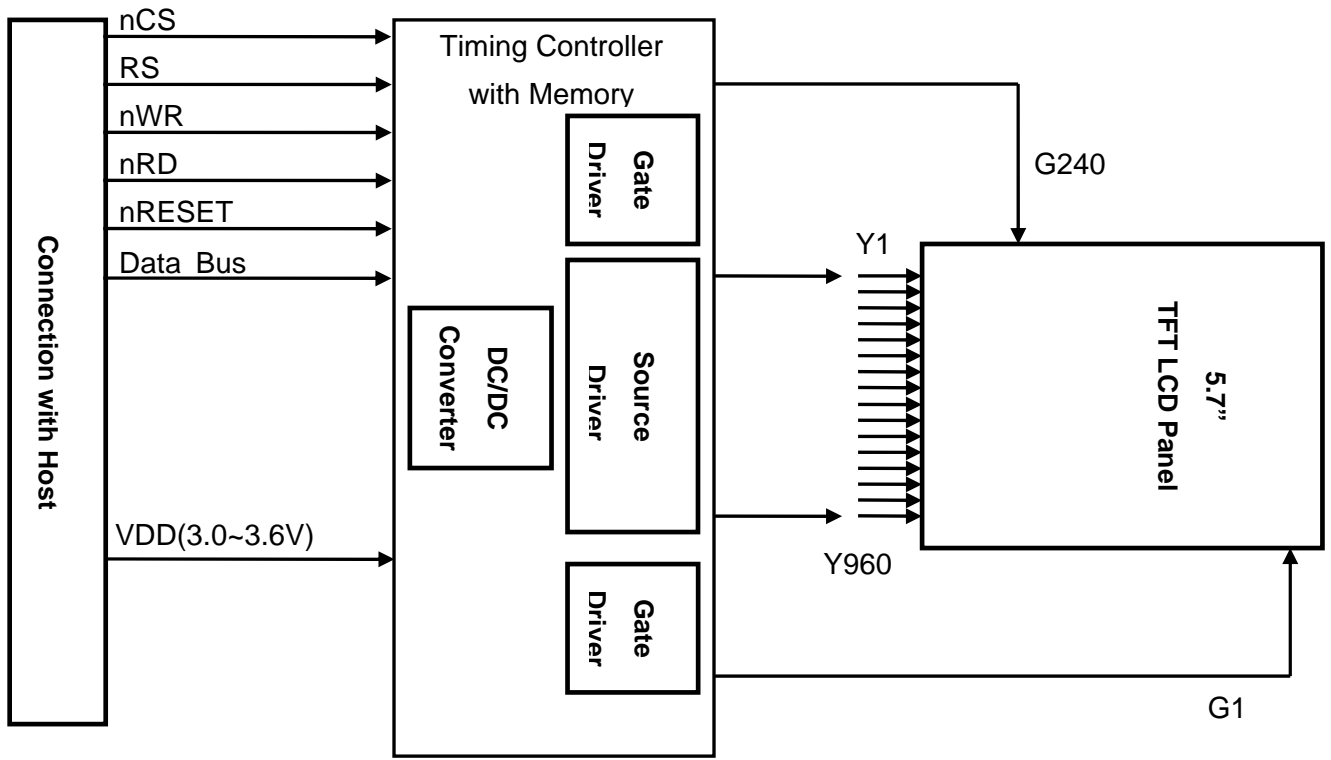

Messrs.					
Product Specification	Model:	MTF-TQ57SN741-AV	Rev. No.	Issued Date.	Page.
			B	Jan.17, 08	7 / 28

4. OPTICAL CHARACTERISTICS

The following items are measured under stable conditions. The optical characteristics should be measured in a dark room or equivalent state with the methods shown in Note (1).

Measuring equipment: LCD-5000, BM-5A, BM-7, PR-650, EZ-Contrast

(Ta=25°C, I_F=300mA)

Item		Symbol	Condition	Min	Type	Max	Unit	Note
Brightness	MTF-TQ57SN741-AV	Br	300mA/6.6V	-	500	-	cd/m ²	Note 1
	MTF-TQ57SP741-AV			-	400	-	cd/m ²	
Response time		T _r	θ=0°	-	15	20	ms	Note 2
		T _f		-	35	50	ms	
Contrast ratio		CR	At optimized viewing angle	150	250	-	-	Note 3
Color Chromaticity	Red	R _x	θ=0° Normal Viewing Angle	0.610	0.640	0.670	-	-
		R _y		0.314	0.344	0.374		
	Green	G _x		0.268	0.298	0.328	-	
		G _y		0.553	0.583	0.613		
	Blue	B _x		0.107	0.137	0.167	-	
		B _y		0.139	0.159	0.179		
	White	W _x		0.282	0.312	0.342	-	
		W _y		0.319	0.349	0.379		
Viewing Angle (6H)	Hor.	θ _R	CR≥10	-	65	-	Degree	Note 4
		θ _L		-	65	-		
	Ver.	θ _B		-	50	-		
		θ _F		-	65	-		
LED Life time	25°C	LL	I _F =300mA V _F =6.6V	-	50k	-	Hours	Note 5

Note 1 : Test Equipment Setup

After stabilizing and leaving the panel alone at a given temperature for 30 min., the measurement should be executed. Measurement should be executed in a stable, windless, and dark room, 30 min. after turning the back light on. This should be measured in the center of screen.

Back-Light current: 300mA

Environment condition: 1. Ta=25±2°C

2. Illuminations ≤ 1 lux



Microtips Technology Inc.

Messrs.					
Product Specification	Model:	MTF-TQ57SN741-AV	Rev. No.	Issued Date.	Page.
			B	Jan.17, 08	8 / 28

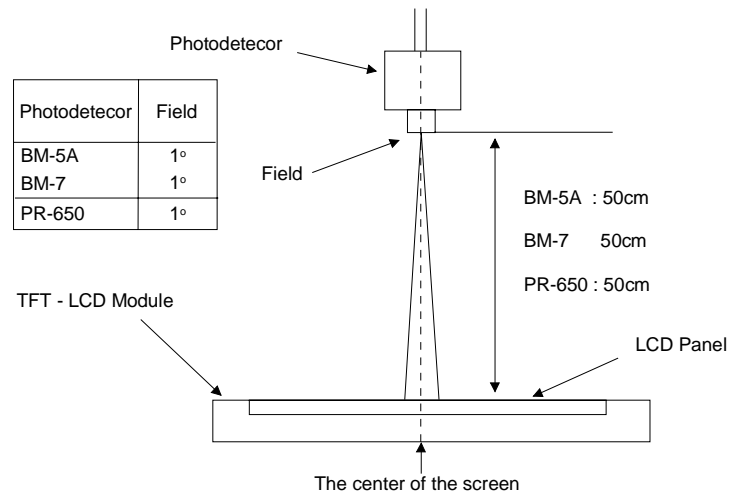

Note 2 : Definition of response time: Tr and Tf

The response time is defined as the following figure and shall be measured by switching the input signal for "black" and "white".

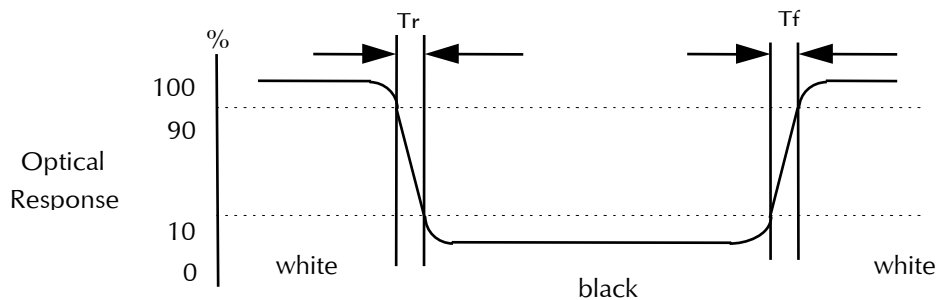

Note 3 : Definition of contrast ratio:

$$\text{Contrast Ratio (CR)} = \frac{\text{Brightness measured when LCD is at "white state"}}{\text{Brightness measured when LCD is at "black state"}}$$

Note 4 : Measured at the center area of the panel when all the input terminals of LCD panel are electrically opened.



Microtips Technology Inc.

Messrs.					
Product Specification	Model:	MTF-TQ57SN741-AV	Rev. No.	Issued Date.	Page.
			B	Jan. 17, 08	9 / 28

View Angle

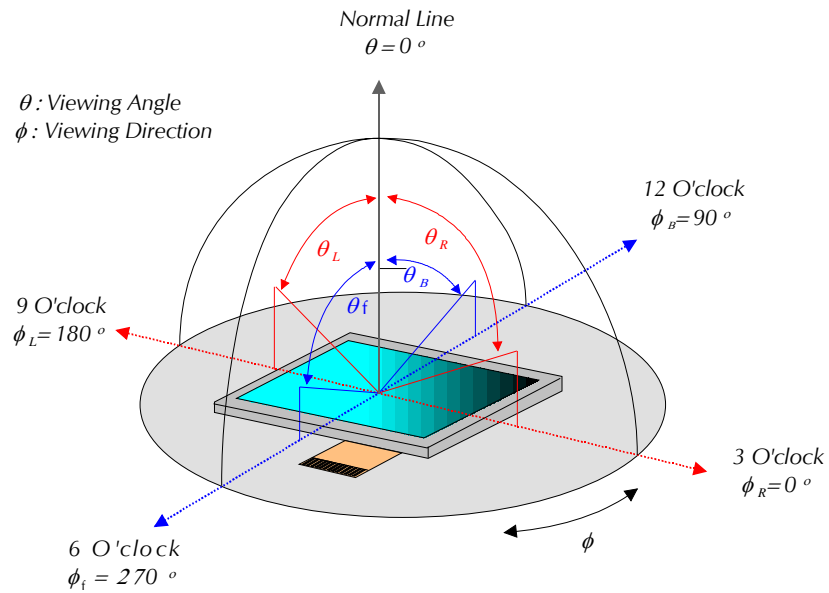

Note 5 : This is the reference value. The white-LED life time is defined as a time when brightness not to become under 50% of the original value (at Ta=25°C)



Microtips Technology Inc.

Messrs.					
Product Specification	Model:	MTF-TQ57SN741-AV	Rev. No.	Issued Date.	Page.
			B	Jan. 17, 08	10 / 28

5. ABSOLUTE MAXIMUM RATINGS

5.1 Absolute Ratings of Environment

If the operating condition exceeds the following absolute maximum ratings, the TFT LCD module may be damaged permanently.

($T_a=25^{\circ}\text{C}$, $V_{SS}=\text{GND}=0$)

Item	Symbol	Min.	Max.	Unit	Note
Storage temperature	T_{STG}	-30	80	$^{\circ}\text{C}$	(1)
Operating temperature (Ambient temperature)	T_{OPR}	-20	70	$^{\circ}\text{C}$	(1), (2)

Note (1) 95 % RH Max. ($40^{\circ}\text{C} \geq T_a$)

Maximum wet-bulb temperature at 39°C or less. ($T_a > 40^{\circ}\text{C}$) No condensation.

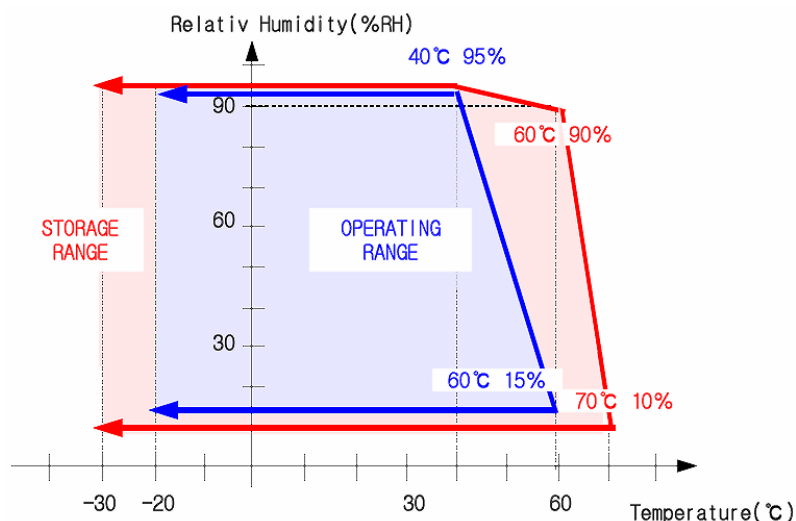

- (2) In case of below 0° , the response time of liquid crystal (LC) becomes slower and the color of panel becomes darker than normal one. Level of retardation depends on temperature, because of LC's character



Microtips Technology Inc.

Messrs.					
Product Specification	Model:	MTF-TQ57SN741-AV	Rev. No.	Issued Date.	Page.
			B	Jan.17, 08	11 / 28

5.2 Electrical Absolute Maximum Rating

(Ta=25°C, V_{SS}=GND=0)

Parameter	Symbol	Min.	Typ.	Max.	Unit	Remark
Power Supply Voltage	V _{DD}	-0.3	--	+7.0	V	Note 1
Permissible input ripple voltage	V _{RF}	--	--	100	mVp-p	V _{DD} = +3.3V
Input voltage (Low)	V _{IL}	0	--	0.3 V _{DD}	V	Note 2
Input voltage (High)	V _{IH}	0.7 V _{DD}	--	+5.5	V	
Input current (Low)	I _{OL1}	--	--	10	μA	V _I =0V, Note 2
Input current (High)	I _{OH1}	--	--	10	μA	V _I =3.3~5.0V, Note 3
	I _{OH2}	--	--	100	μA	V _I =3.3~5.0V, Note 4

Note1:

V_{DD}-turn-on conditions

$$0 < t1 \leq 20\text{ms}$$

$$0 < t2 \leq 50\text{ms}$$

$$0 < t3 \leq 1\text{s}$$

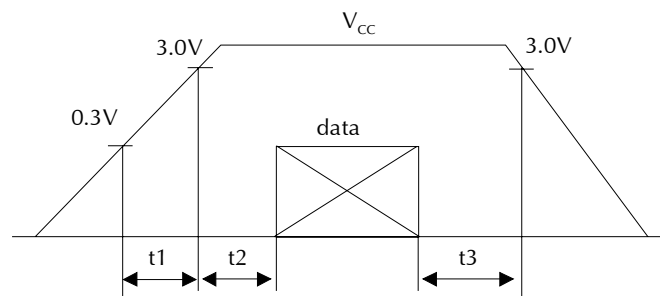

V_{DD}-dip conditions

V_{DD}-dip conditions should also follow the V_{DD}-turn-on conditions

$$T_d \leq 20\text{ms}$$

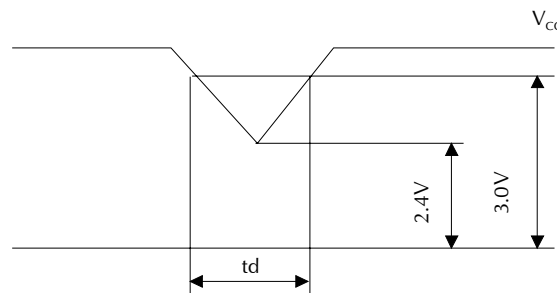

Note2: CLK, R0~R5, G0~G5, B0~B5, Hsync, Vsync, DE, R/L, U/D

Note3: CLK, R0~R5, G0~G5, B0~B5, Hsync, Vsync, R/L, U/D

Note4: DE



Microtips Technology Inc.

Messrs.					
Product Specification	Model:	MTF-TQ57SN741-AV	Rev. No.	Issued Date.	Page.
			B	Jan.17, 08	12 / 28

6. 8080 INDIRECT ADDRESSING MODE

6.1 8080 16 bit interface Timing (write cycle)

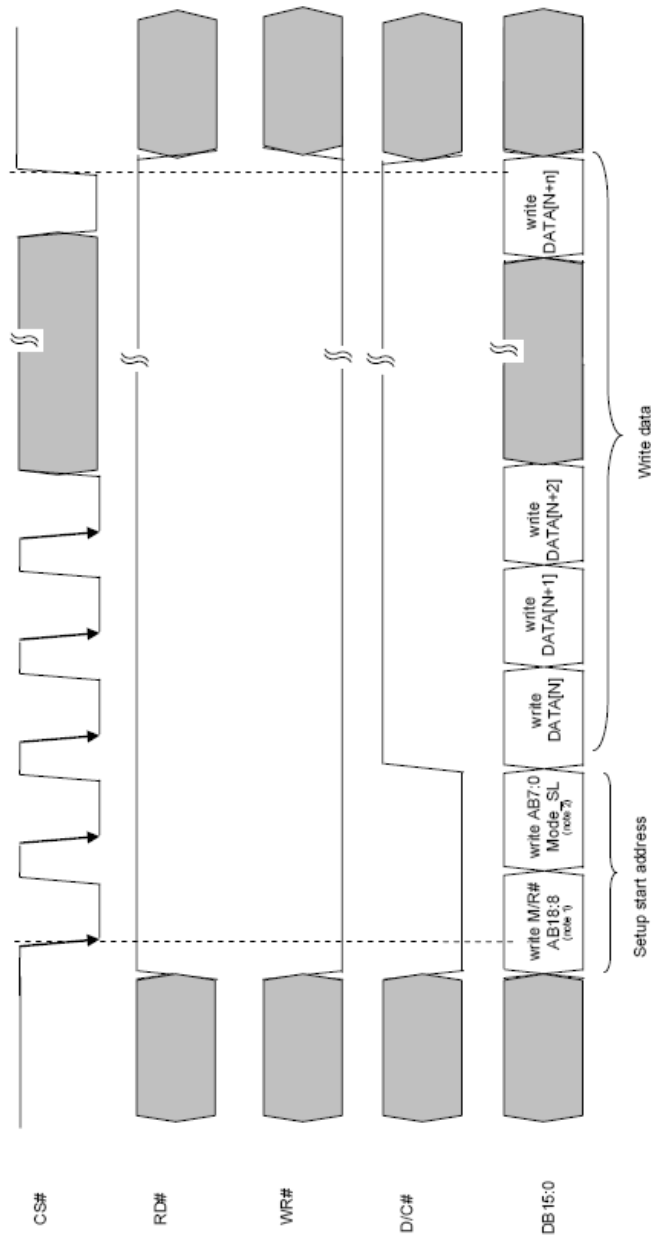

Note :

1 : Bit 15 represent the M/R#, Bit15 = 1 means memory access, Bit15 = 0 means register access.
Bit 14:11 = 0.

2 : Bit 10:0 represent the the address AB18:8.

Bit 15:8 represent the address AB7:0 and Bit7:0 represent Mode_SL.

Mode_SL to select byte or word access during 16 bit mode. 0x00 means Byte access, 0x01 means word access.

* 7 MCLK is needed for each cycle if WAIT# is not used for interface.



Messrs.					
Product Specification	Model:	MTF-TQ57SN741-AV	Rev. No.	Issued Date.	Page.
			B	Jan.17, 08	13 / 28

6.2 8080 16 bit interface Timing (read cycle)

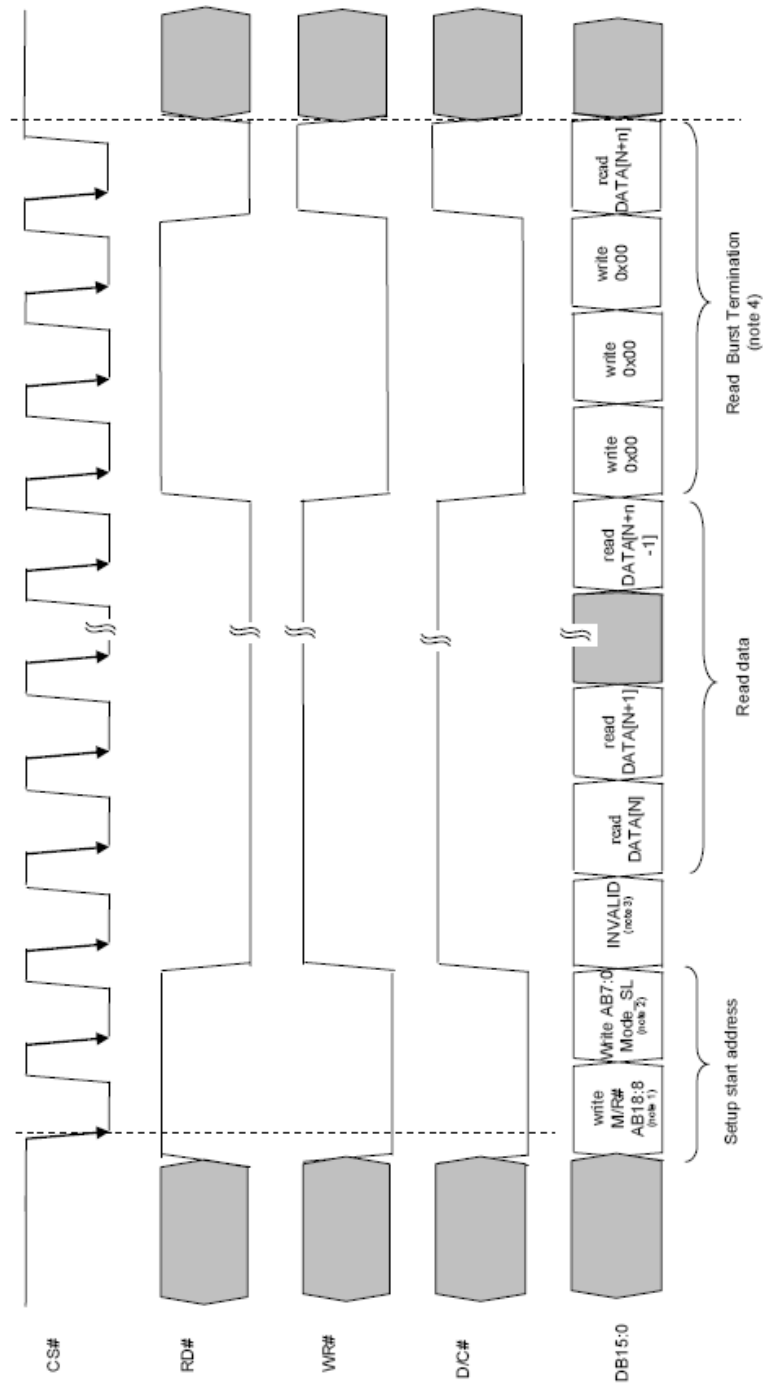

- Note :
- 1 : Bit15 represent the M/R#, Bit15 = 1 means memory access, Bit15 = 0 means register access. Bit14:11 = 0.
 - 2 : Bit10:0 represent the the address AB18:8.
 - 3 : Bit15:8 represent the address AB7:0 and Bit7:0 represent Mode_SL. Mode_SL to select by te or word access during 16 bit mode. 0x00 means Byte access, 0x01 means word access.
 - 4 : Invalid dummy data cycle is needed after address is written. Read Burst Termination must be asserted for all JPEG related memory access.
- * 7 MCLK is needed for each cycle if WAIT# is not used for interface.



Messrs.					
Product Specification	Model:	MTF-TQ57SN741-AV	Rev. No.	Issued Date.	Page.
			B	Jan.17, 08	14 / 28

6.3 8080 indirect interface Timing

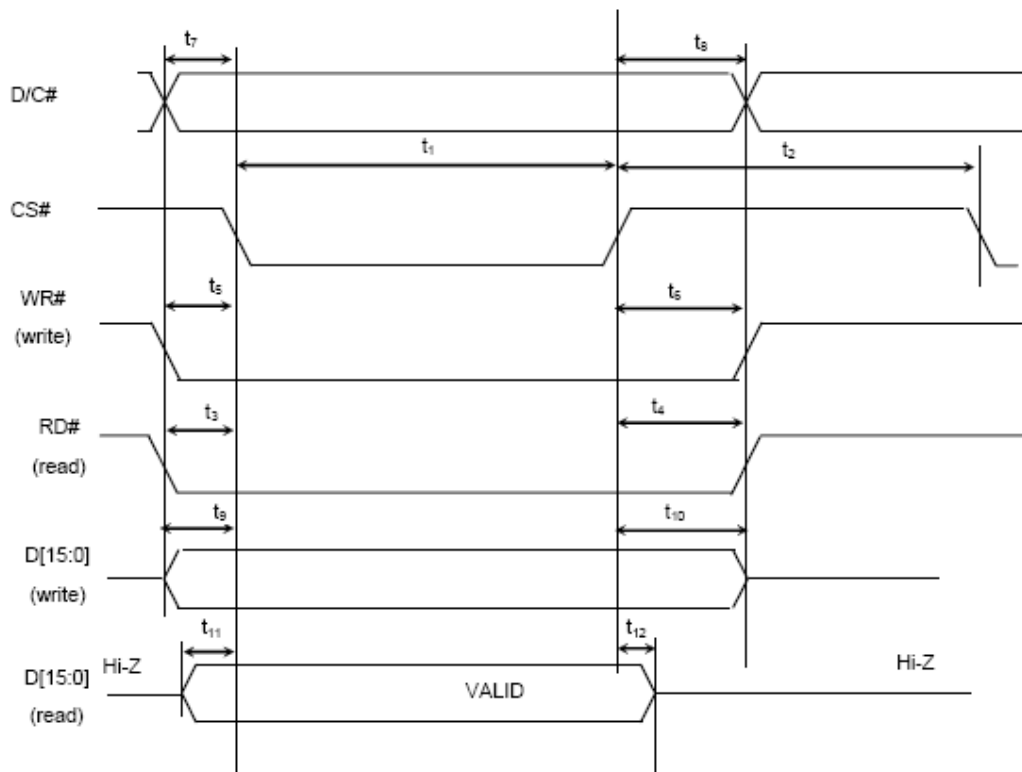

Symbol	Parameter	Min	Max	Units
t_1	CS# pulse width low	82		ns
t_2	CS# pulse width high	82		ns
t_3	RD# setup	18		ns
t_4	RD# hold	0		ns
t_5	WR# setup	18		ns
t_6	WR# hold	0		ns
t_7	D/C# setup	18		ns
t_8	D/C# hold	0		ns
t_9	D[15:0] setup for write	18		ns
t_{10}	D[15:0] hold for write	0		ns
t_{11}	D[15:0] delay for read	55		ns
t_{12}	D[15:0] hold for read	0		ns

Note : Above timing is based on MCLK = 85MHz



Microtips Technology Inc.

Messrs.					
Product Specification	Model:	MTF-TQ57SN741-AV	Rev. No.	Issued Date.	Page.
			B	Jan. 17, 08	15 / 28

7. ELECTRICAL CHARACTERISTICS

7.1 DC Electrical Characteristics

($T_a=25\pm 2^\circ\text{C}$, $V_{SS}=\text{GND}=0$)

Item	Symbol	Min.	Typ.	Max.	Unit	Remark	
Supply Voltage	V_{DD}	3.0	3.3	3.6	V	-	
Supply Current	I_{DD}	89	85	82	mA	Note 1	
Input Voltage for logic	L Level	V_{IH}	$0.7 V_{DD}$	-	V_{DD}	V	-
	H Level	V_{IL}	0	-	$0.3 V_{DD}$	V	-

Note1: $f_V=60\text{Hz}$, $T_a=25^\circ\text{C}$, Display pattern : All Black



Messrs.					
Product Specification	Model:	MTF-TQ57SN741-AV	Rev. No.	Issued Date.	Page.
			B	Jan.17, 08	16 / 28

8. BACKLIGHT SPECIFICATIONS

8.1 Absolute Maximum Ratings

Ta=25°C

Item	Symbol	Maximum rating	Unit	Note
Peak Forward Current	I _{FM}	450	mA	(1)
Reverse Voltage	V _R	10	V	-
Power Dissipation	P _D	3300	mW	-
Operating Temperature	T _{OP}	-20~70	°C	-
Storage Temperature	T _{ST}	-30~80	°C	-

Note (1): Permanent damage to the device may occur if maximum values are exceeded or reverse voltage is loaded.

Functional operation should be restricted to the conditions described under normal operating conditions.

8.2 Electrical/Operating Characteristics

Ta = 25°C

Parameter	Symbol	Min.	Typ.	Max.	Units	Test Condition
Forward Voltage	V _F	-	6.6	-	V	Ta=25°C IF=300mA
LED Current	I _F	-	300	-	mA	
Uniformity*	-	75	-	-	%	
Chromaticity Coordinates	X	0.26	0.29	0.32	-	
	Y	0.26	0.29	0.32	---	

*: Uniformity = (Min./Max.) x 100%

Unregistered HyperSnap

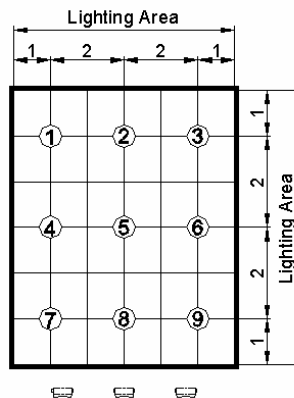

Microtips Technology Inc.

Messrs.					
Product Specification	Model:	MTF-TQ57SN741-AV	Rev. No.	Issued Date.	Page.
			B	Jan.17, 08	17 / 28

9. DISPLAYED COLOR AND INPUT DATA

	Color & Gray Scale	Data Signal																	
		R5	R4	R3	R2	R1	R0	G5	G4	G3	G2	G1	G0	B5	B4	B3	B2	B1	B0
Basic Color	Black	1	1	1	1	1	1	1	1	1	1	1	1	1	1	1	1	1	1
	Red(0)	0	0	0	0	0	0	1	1	1	1	1	1	1	1	1	1	1	1
	Green(0)	1	1	1	1	1	1	0	0	0	0	0	0	1	1	1	1	1	1
	Blue(0)	1	1	1	1	1	1	1	1	1	1	1	1	0	0	0	0	0	0
	Cyan	1	1	1	1	1	1	0	0	0	0	0	0	0	0	0	0	0	0
	Magenta	0	0	0	0	0	0	1	1	1	1	1	1	0	0	0	0	0	0
	Yellow	0	0	0	0	0	0	0	0	0	0	0	0	1	1	1	1	1	1
	White	0	0	0	0	0	0	0	0	0	0	0	0	0	0	0	0	0	
Red	Black	1	1	1	1	1	1	1	1	1	1	1	1	1	1	1	1	1	
	Red(62)	1	1	1	1	1	0	1	1	1	1	1	1	1	1	1	1	1	
	Red(61)	1	1	1	1	0	1	1	1	1	1	1	1	1	1	1	1	1	
	:	:	:	:	:	:	:	:	:	:	:	:	:	:	:	:	:	:	
	Red(31)	1	0	0	0	0	0	1	1	1	1	1	1	1	1	1	1	1	
	:	:	:	:	:	:	:	:	:	:	:	:	:	:	:	:	:	:	
	Red(1)	0	0	0	0	0	1	1	1	1	1	1	1	1	1	1	1	1	
	Red(0)	0	0	0	0	0	1	1	1	1	1	1	1	1	1	1	1	0	
Green	Black	1	1	1	1	1	1	1	1	1	1	1	1	1	1	1	1	1	
	Green(62)	1	1	1	1	1	1	1	1	1	1	1	0	1	1	1	1	1	
	Green(61)	1	1	1	1	1	1	1	1	1	1	0	1	1	1	1	1	1	
	:	:	:	:	:	:	:	:	:	:	:	:	:	:	:	:	:	:	
	Green(31)	1	1	1	1	1	1	1	0	0	0	0	1	1	1	1	1	1	
	:	:	:	:	:	:	:	:	:	:	:	:	:	:	:	:	:	:	
	Green(1)	1	1	1	1	1	1	0	0	0	0	0	1	1	1	1	1	1	
	Green(0)	1	1	1	1	1	1	0	0	0	0	0	1	1	1	1	1	1	
Blue	Black	1	1	1	1	1	1	1	1	1	1	1	1	1	1	1	1	1	
	Blue(62)	1	1	1	1	1	1	1	1	1	1	1	1	1	1	1	1	0	
	Blue(61)	1	1	1	1	1	1	1	1	1	1	1	1	1	1	1	0	1	
	:	:	:	:	:	:	:	:	:	:	:	:	:	:	:	:	:	:	
	Blue(31)	1	1	1	1	1	1	1	1	1	1	1	1	1	0	0	0	0	
	:	:	:	:	:	:	:	:	:	:	:	:	:	:	:	:	:	:	
	Blue(1)	1	1	1	1	1	1	1	1	1	1	1	1	0	0	0	0	1	
	Blue(0)	1	1	1	1	1	1	1	1	1	1	1	0	0	0	0	0	0	

0 : Low level voltage, 1 :High level voltage

Each basic color can be displayed in 64 gray scales from 6 bit data signals. With the combination of total 18 bit data signals, the 262,144-color display can be achieved on the screen.



Microtips Technology Inc.

Messrs.					
Product Specification	Model:	MTF-TQ57SN741-AV	Rev. No.	Issued Date.	Page.
			B	Jan. 17, 08	18 / 28

10. QUALITY STANDARD FOR LCD

10.1 Objective

This specification book is the standard for LCD module general inspection. And also this book will be refer to customer approval specification.

10.2 Scope

This specification book is applicable to general LCD module. If supplier has any doubt or requirement, then it can be discussed.

10.2.1 Acceptable Quality Level

INSPECTION	SAMPLING PROCEDURES	A.Q.L
Major	MIL-STD-105E Inspection Level II Normal Inspection Single sample inspection	1
Minor	MIL-STD-105E Inspection Level II Normal Inspection Single sample inspection	1.5

Major defect :

A major defect is a defect that could result in failure or extremely reduction on the usability of the product for its intended purpose.

Minor defect :

A minor defect is one that does not materially reduce the usability of the product for its intended purpose or is a departure from established standards giving no significant bearing on the effective use or operation of the unit.

10.2.2 Inspection Conditions

10.2.2.1 The environmental conditions for inspection shall be as follows

- Room Temperature : 25±10°C
- Humidity Temperature : 45±20%RH

10.2.3 The external visual inspection

- The inspection shall be performed by using 40Watts fluorescent lamp for illumination and the distance between LCD and eyes of the inspector shall be 30cm or more.



Messrs.					
Product Specification	Model:	MTF-TQ57SN741-AV	Rev. No.	Issued Date.	Page.
			<i>B</i>	<i>Jan. 17, 08</i>	<i>19 / 28</i>

10.2.4 Inspection Item

Pinhole, Bright spot, Black spot, White spot, Black line, White Line, Foreign particle, Bubble	The color of a small area is different from the remainder. The phenomenon dose not change with voltage.
Contrast variation	The color of a small area is different from the remainder. The phenomenon change with voltage.
Glass defect	Glass crack, Chip
Operating	Function, Contrast, Uniformity, Components

10.2.5 Definition of the Area

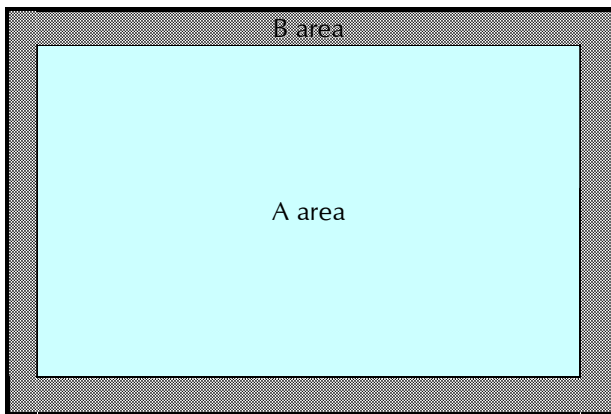

A area: Viewing Area
 B area: Out of Viewing Area



Messrs.					
Product Specification	Model:	MTF-TQ57SN741-AV	Rev. No.	Issued Date.	Page.
			B	Jan.17, 08	20 / 28

10.3 Inspection specification

10.3.1 Non-operating inspection specification

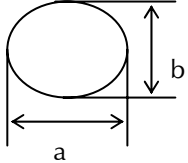
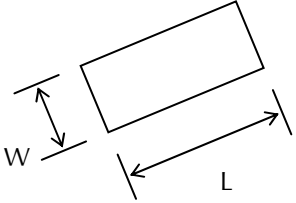
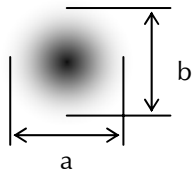
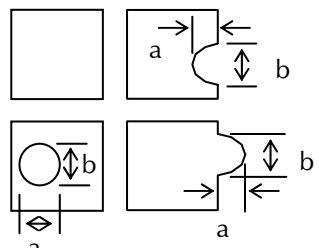
Class of defects	No.	Inspection Item	Criteria of defects		Acceptable Q'ty	
					Zone A	Zone B
Major	1	Circuits	1. Circuit short		0	0
			2. Circuit open			
Minor	2	Black spot, White spot, Bright spot, Foreign particle  $\phi = (a+b)/2$	A	$\phi \leq 0.3$	Ignore	
			B	$0.3 < \phi \leq 0.4$	4	
			C	$0.4 < \phi \leq 0.5$	2	
			D	$0.5 < \phi$	0	
			Total defect point (B,C)		4	
	* Reject when 5 or more spots are gathered within 5mm circle.					
	3	Black line, White line 	A	$W \leq 0.02$	-	*
			B	$0.02 < W \leq 0.05$	$L \leq 5$	2
			C	$0.05 < W \leq 0.1$	$L \leq 3$	2
			D	$0.1 < W$	-	0
Total defect point (B,C)			3		Ignore	
* Reject when 5 or more spots are gathered within 5mm circle.						
4	Contrast variation  $\phi = (a+b)/2$	A	$\phi \leq 0.3$	Ignore		
		B	$0.3 < \phi \leq 0.4$	4		
		C	$0.4 < \phi \leq 0.5$	2		
		D	$0.5 < \phi$	0		
		Total defect point (B,C)		4		Ignore
5	 $\phi = (a+b)/2$	1. Pin hole				
		A	$\phi \leq 0.15$	Ignore		
		B	$0.15 < \phi \leq 0.2$	2 (*)		
			$0.2 < \phi$	0		
		* Two pin hole shall not formed in the single dot				
		2. Excess, void				
A	$a \leq 0.2$ & $b \leq 0.2$	Ignore				
B	$0.2 < a$ or $0.2 < b$	0				



Messrs.					
Product Specification	Model:	MTF-TQ57SN741-AV	Rev. No.	Issued Date.	Page.
			B	Jan. 17, 08	21 / 28

Minor	6	Dot defect	A	Bright dot	$N \leq 2$	Ignore
			B	Dark dot	$N \leq 3$	
			C	Total Bright & Dark Dots	$N \leq 4$	
			* This inspection item does not apply to B/W LCD			
	7	Bubble between Polarizer and panel	A	$\varphi \leq 0.3$	Ignore	Ignore
			B	$0.3 < \varphi \leq 0.5$	2	
			C	$0.5 < \varphi$	0	
	8	Polarizer scratch and particle	Circular : Same as inspection item No.2			Ignore
			Linear : Same as inspection item No.3			
	9	Polarizer Dent	A	$\varphi \leq 0.2$	Ignore	Ignore
			B	$0.2 < \varphi \leq 0.3$	4	
			C	$0.3 < \varphi \leq 0.5$	2	
			D	$0.5 < \varphi$	0	
			Total defect point (B,C)		3	
	10	Bubble in the Cell	Any size		0	0
11	Dirt on polarizer	Dirt which can be wiped easily should be accepted.				
12	Protection film	The protection film should not be stripped up to viewing area and the peeled off angle should not exceed 20 degrees.				
13	Polarizer shift	<ol style="list-style-type: none"> Shifting in position should not exceed the glass outline dimension. Incomplete covering of the viewing area due to shifting is not allowed. Shifting in position should be within the tolerance (refer to module dimensional drawing) 				
14	Silicon	<ol style="list-style-type: none"> Silicon must cover all circuits. Silicon thickness should be within specification (refer to module dimensional drawing) 				
15	Tape	<ol style="list-style-type: none"> Location: refer to specification. Insufficient adhesive. 				
Major	16	TCP, FPC defect	Film or Pattern should not have crack.			
	17	Components	Missing components not allowed.			



Messrs.					
Product Specification	Model:	MTF-TQ57SN741-AV	Rev. No.	Issued Date.	Page.
			<i>B</i>	<i>Jan. 17, 08</i>	<i>22 / 28</i>

Class of defects	No.	Inspection Item	Criteria of defects
Major	1	No display	--
	2	Abnormal operation	--
	3	Contrast defect	Judge according to module specification. Establish boundary sample if required.
	4	Viewing angle defect	Judge according to module specification. Establish boundary sample if required.
	5	Excess power consumption	Judge according to module specification.
	6	Back-light, LED defect	1. No lit-on 2. Different color 3. Low brightness
	7	Speaker, Vibrator defect	1. No operation 2. Abnormal operation
Minor	8	Cross-talk defect	No noticeable crosstalk. Establish boundary sample if required.
	9	Uneven brightness	No noticeable unevenness allowed. Establish boundary sample if required.
	10	Uneven color	No noticeable unevenness allowed. Establish boundary sample if required.
	11	Spot, Pinhole, Foreign particle, Line	Same as in Chapter 7.1



Messrs.					
Product Specification	Model:	MTF-TQ57SN741-AV	Rev. No.	Issued Date.	Page.
			B	Jan.17, 08	23 / 28

11. RELIABILITY CONDITION

11.1 LCM Reliability Test

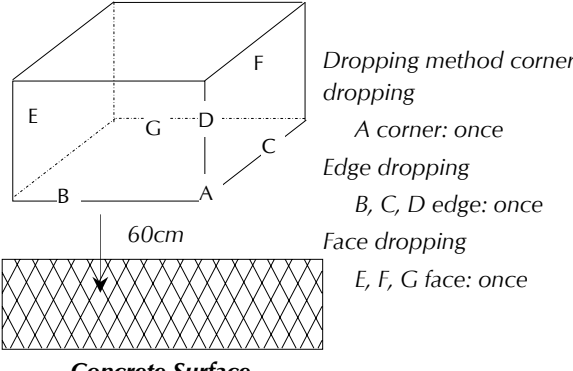
No.	Parameter	Condition
1	High Temperature Operating	70°C±2°C, 240 hrs (Operation state)
2	Low Temperature Operating	-20°C±2°C, 240 hrs (Operation state)
3	High Temperature Storage	80°C±2°C, 240 hrs
4	Low Temperature Storage	-30°C±2°C, 240 hrs
5	Damp Proof Test	40°C±2°C, 90~95%, 96hrs
6	Vibration Test	Total fixed amplitude: 1.5mm Vibration Frequency: 10~55Hz One cycle 60 seconds to 3 direction of X, Y, Z each 15 minutes.
7	Shock Test	To be measured after dropping from 60cm high on the concrete surface in packing state. 

- Notes:
1. No dew condensation to be observed.
 2. The function test shall be conducted after 4 hours storage at the normal temperature and humidity after removed from the test chamber.
 3. Vibration test will be conducted to the product itself without putting I in a container.



Messrs.					
Product Specification	Model:	MTF-TQ57SN741-AV	Rev. No.	Issued Date.	Page.
			B	Jan. 17, 08	24 / 28

12. PRECAUTIONS





12.1 Operation

Burn-in sometimes happens when the same character was displayed at long time. Therefore, to prevent Burn-in, it is recommended to set up a Screen-saver function.

12.2 Safety

The liquid crystal in the LCD is poisonous, DO NOT put it in your mouth. If the liquid crystal touches your skin or clothes, wash it off immediately using soap and water.







12.3 Handling

	<p>a. The LCD module shall be installed flat, without twisting or bending.</p> <p>b. COF or FPC has narrow pattern width, so easily become open circuit by external force. DO NOT apply pressure to COF or FPC especially in bending area.</p>
	<p>c. To avoid damage in appearance or malfunction, DO NOT subject the module to mechanical shock or to excessive force on its surface.</p>
	<p>d. The polarizer attached to the display is very easy to be damaged, handle it with care to avoid scratching.</p>
	<p>e. To avoid contamination on the display surface, DO NOT touch the display surface with bare hands.</p> <p>f. Provide a space so that the LCD module does not come into contact with other components.</p>

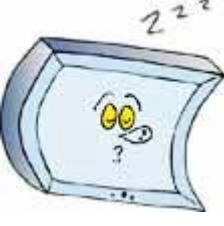

Messrs.

Product Specification	Model:	MTF-TQ57SN741-AV	Rev. No.	Issued Date.	Page.
			B	Jan. 17, 08	25 / 28

	<p>g. To protect the LCD panel from external pressure, put covering glass (acrylic board or similar board) to keep appropriate space between them.</p>
	<p>h. Be careful for condensation at sudden temperature change. Condensation makes damage to polarizer or electrical contacted parts. And after fading condensation, smear or spot will occur.</p>
	<p>i. Property of semiconductor devices may be affected when they are exposed to light possibly resulting in malfunctioning of the ICs. To prevent such malfunctioning of the ICs, your design and mounting layout done are so that the IC is not exposed to light in actual use.</p>
	<p>j. Strong light exposure causes degradation of color filter. It may not recover</p>
	<p>k. DO NOT contact with water to avoid Metal corrosion.</p> <p>l. When it is not in use, the screen must be turned off or the pattern must be frequently changed by a screen saver. If it displays the same pattern for a long period of time, brightness down/image sticking may develop due to the LCD structure.</p>
	<p>m. Never disassemble LCD product under any circumstances. If unqualified operators or users assemble the product after disassembling it, it may not function or its operation may be seriously affected.</p>



Messrs.					
Product Specification	Model:	MTF-TQ57SN741-AV	Rev. No.	Issued Date.	Page.
			B	Jan. 17, 08	26 / 28

12.4 Static electricity

Since a module is composed of electronic circuits, it is not strong to electrostatic discharge.

	<ol style="list-style-type: none"> The LCD module shall be installed flat, without twisting or bending. Ground soldering iron tips, tools and testers when they operate. Ground your body when handling the products. DO NOT apply voltage to the input terminal without applying power supply. DO NOT apply voltage that exceeds the absolute maximum rating. Store the products in an anti-electrostatic container. Peel off protect tape, attached to polarizer, slowly to minimize ESD damage.
---	--

12.5 Storage

	<p>Store the products in a dark place at +5 ~ +25 degree C, low humidity (50%RH or less). DO NOT store the products in an atmosphere containing organic solvents or corrosive gases.</p>
---	--

12.6 Cleaning

	<ol style="list-style-type: none"> DO NOT wipe the polarizer with dry cloth, as it might cause scratch. Wipe the polarizer with a soft cloth soaked with petroleum IPA, other chemical might damage.
---	--

12.7 Waste

	<p>When dispose of LCD module, manage it at the production waste according to the relevant laws and regulations.</p>
---	--



Messrs.					
Product Specification	Model:	MTF-TQ57SN741-AV	Rev. No.	Issued Date.	Page.
			<i>B</i>	<i>Jan. 17, 08</i>	<i>27 / 28</i>

13. WARRANTY

This product has been manufactured to your company's specifications as a part for use in your company's general electronic products. It is guaranteed to perform according to delivery specifications. For any other use apart from general electronic equipment, we cannot take responsibility if the product is used in medical devices, nuclear power control equipment, aerospace equipment, fire and security systems, or any other applications in which there is a direct risk to human life and where extremely high levels of reliability are required. If the product is to be used in any of the above applications, we will need to enter into a separate product liability agreement.

- 1 We cannot accept responsibility for any defect, which may arise from additional manufacturing of the product (including disassembly and reassembly), after product delivery.
- 2 We cannot accept responsibility for any defect, which may arise after the application of strong external force to the product.
- 3 We cannot accept responsibility for any defect, which may arise due to the application of static electricity after the product has passed your company's acceptance inspection procedures.
- 4 We cannot accept responsibility for industrial property, which may arise through the use of your product, with exception to those issues relating directly to the structure or method of manufacturing of our product. Microtips-origin longer than one year from Microtips production.

14. DIMENSIONAL OUTLINES

See next page.....



Microtips Technology Inc.

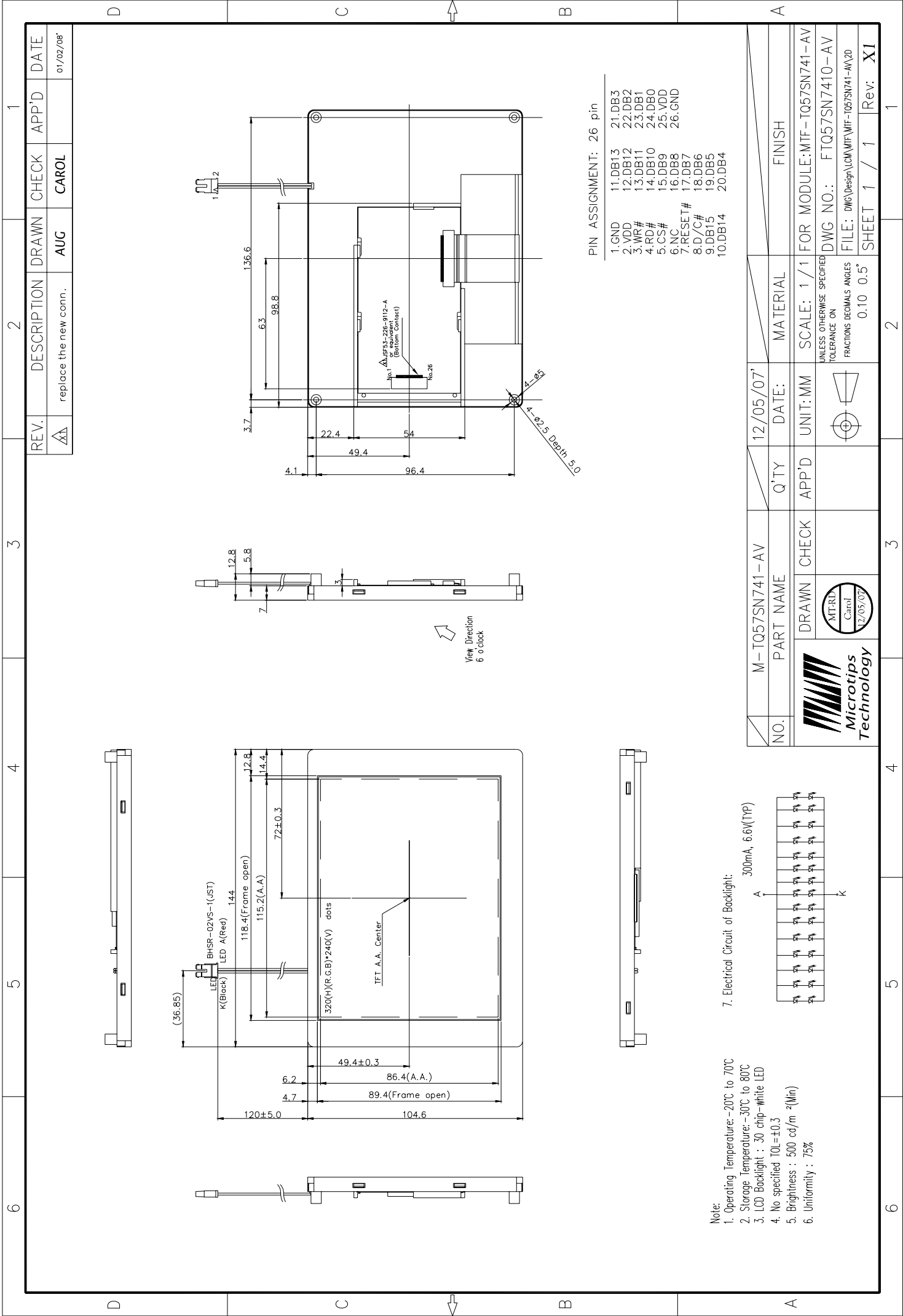

REV.	DESCRIPTION	DRAWN	CHECK	APP'D	DATE
1	replace the new conn.	AUG	CAROL		01/02/08



PIN ASSIGNMENT: .26 pin

1.GND	11.DB13	21.DB3
2.VDD	12.DB12	22.DB2
3.WR#	13.DB11	23.DB1
4.RD#	14.DB10	24.DB0
5.CS#	15.DB9	25.VDD
6.NC	16.DB8	26.GND
7.RESET#	17.DB7	
8.D/C#	18.DB6	
9.DB15	19.DB5	
10.DB14	20.DB4	

- Note:
1. Operating Temperature: -20°C to 70°C
 2. Storage Temperature: -30°C to 80°C
 3. LCD Backlight : 30 chip-white LED
 4. No specified TOL=±0.3
 5. Brightness : 500 cd/m²(Min)
 6. Uniformity : 75%

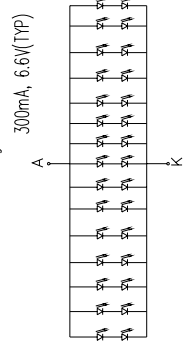
7. Electrical Circuit of Backlight:



NO.	M-TQ57SN741-AV	Q'TY	DATE:	12/05/07
PART NAME		APP'D	UNIT:MM	
DRAWN CHECK		SCALE: 1 / 1		
		UNLESS OTHERWISE SPECIFIED TOLERANCE ON FRACTIONS DECIMALS ANGLES 0.10 0.5°		
		FOR MODULE:M/F-TQ57SN741-AV		
		DWG NO.: FTQ57SN7410-AV		
		FILE: DWG\Design\LCM\M\F-TQ57SN741-AV\2D		
		SHEET 1 / 1		
		Rev: XI		