





Messrs.					
Product Specification	Model:	MTF-TW70SN911-LB	Rev. No.	Issued Date.	Page.
			A	May.07, 09	1 / 23

**LIQUID CRYSTAL DISPLAY MODULE**  
**MODEL: MTF-TW70SN911-LB**  
**Customer's No.:**

Acceptance

*Microtips Technology Inc.*  
*12F. No.31 Lane 169, Kang Ning St.,*  
*Hsi-Chih, Taipei Hsien, Taiwan*  
*FAX: 886-2-26958625*

Approved and Checked by

Approved by	Checked by		Made by
			



*Microtips Technology Inc.*



Messrs.					
Product Specification	Model:	MTF-TW70SN911-LB	Rev. No.	Issued Date.	Page.
			A	May.07, 09	3 / 23

## *Contents*

<b>1.</b>	<b>GENERAL DESCRIPTION AND FEATURES</b> .....	4
1.1	Features .....	4
1.2	LCD Module .....	4
<b>2.</b>	<b>ELECTRICAL SPECIFICATIONS</b> .....	5
2.1	Absolute Max. Ratings.....	5
2.2	Electrical Characteristics .....	5
<b>3.</b>	<b>OPTICAL CHARACTERISTICS</b> .....	6
3.1	Optical characteristic of the LCD .....	6
3.2	LED Driving Conditions.....	9
<b>4.</b>	<b>INPUT SIGNAL (DE ONLY MODE)</b> .....	10
4.1	Timing Specification.....	10
4.2	Timing Controller Timing Chart .....	11
<b>5.</b>	<b>PIN ASSIGNMENT</b> .....	14
5.1	LCM Pin Definition .....	14
5.2	Backlight Driving Part.....	15
<b>6.</b>	<b>BLOCK DIAGRAM</b> .....	16
<b>7.</b>	<b>DISPLAYED COLOR AND INPUT DATA</b> .....	17
<b>8.</b>	<b>RELIABILITY CONDITION</b> .....	18
8.1	Test Item.....	18
<b>9.</b>	<b>PRECAUTIONS</b> .....	19
9.1	Operation.....	19
9.2	Safety .....	19
9.3	Handling.....	19
9.4	Static electricity .....	21
9.5	Storage .....	21
9.6	Cleaning .....	21
9.7	Waste.....	21
<b>10.</b>	<b>WARRANTY</b> .....	22
<b>11.</b>	<b>DIMENSIONAL OUTLINES</b> .....	22



Messrs.					
Product Specification	Model:	MTF-TW70SN911-LB	Rev. No.	Issued Date.	Page.
			A	May.07, 09	4 / 23

## 1. GENERAL DESCRIPTION AND FEATURES

MTF-TW70SN911-LB is a transmissive type color active matrix TFT (Thin Film Transistor) liquid crystal display (LCD) that uses amorphous silicon TFT as a switching devices. This model is composed of a TFT-LCD module, a driver ICs, control circuit and a back-light unit. Graphics and texts can be displayed on a WVGA 800 (W) x 3 x 480 (H) dots (16:9 aspect ratio) with 262,144 colors by supplying 18 bits data signal (6 bits RGB signal input). The following table described the features of MTF-TW70SN911-LB.

### 1.1 Features

- Transmissive and back-light with the LED.
- TN (Twisted Nematic) mode.
- Digital RGB 6 bits TTL data signal input.
- Data enable mode.
- Data inverted function for reducing EMI.

### 1.2 LCD Module

Item		Specification	Unit
Screen Size		7.0 inches	Diagonal
Display Resolution		800 (H) x 480 (V)	Dots
Display Area		152.4 (H) x 91.44 (V)	mm
Outline Dimension		165 (W) x 104.44 (H) x 5.2 (D) Excluding the FPCB tail and the connectors at the backside.	mm
Pixel Pitch		190.5 x 190.5	um
Pixel Arrangement		R,G,B Vertical Stripe	--
Surface Treatment		Anti-Glare	--
Viewing Direction		6 o'clock	--
Temperature Range	Storage	-30 ~ 80	°C
Weight		123g (Typ)	g



Messrs.					
Product Specification	Model:	MTF-TW70SN911-LB	Rev. No.	Issued Date.	Page.
			A	May.07, 09	5 / 23

## 2. **ELECTRICAL SPECIFICATIONS**

### 2.1 Absolute Max. Ratings

#### 2.1.1 Absolute Ratings of Environment

If the operating condition exceeds the following absolute maximum ratings, the TFT LCD module may be damaged permanently.

Item	Symbol	Min.	Max.	Unit	Note
Power supply voltage for LCD	V <sub>CC</sub>	-0.3	6	V	--
Signal input voltage	DCLK, DE, R0, G0, B0-R5, G5, B5	-0.3	V <sub>CC</sub> +0.3	V	--

### 2.2 Electrical Characteristics

#### 2.2.1 TFT LCD

Parameter	Symbol	Min	Typ	Max	Unit	Note
Power Supply Voltage for Digital Circuit	V <sub>CC</sub>	3.0	3.3	3.6	V	--
Logic Input Voltage	High Level	V <sub>IH</sub>	V <sub>CC</sub> *0.7	--	V <sub>CC</sub>	1
	Low Level	V <sub>IL</sub>	0	--	V <sub>CC</sub> *0.3	

Note1: DCLK, DE, R0~R5, G0~G5, B0~B5

#### 2.2.2 TFT-LCD current Consumption

Parameter	Symbol	Min	Typ	Max	Unit	Note
LCD power current	I <sub>CC</sub>	--	150	200	mA	--
LED power current	I <sub>LED</sub>	--	160	200	mA	--



Messrs.					
Product Specification	Model:	MTF-TW70SN911-LB	Rev. No.	Issued Date.	Page.
			A	May.07, 09	6 / 23

### 3. OPTICAL CHARACTERISTICS

#### 3.1 Optical characteristic of the LCD

Item	Symbol	Condition	Min	Type	Max	Unit	Note	
Contrast ratio	CR	At Optimized Viewing angle	250	400	--	--	4,5	
Response time (White-Black)	$T_R$	$\theta = 0^\circ$	--	5	10	ms	3,5	
	$T_F$	$\Phi = 0$	--	11	16			
Color Saturation (NTSC)	--	--	--	45%	--	--	Center of display	
Color Chromaticity	White	$W_x$	$\theta = 0^\circ$	0.269	0.299	0.329	--	2,6,7
		$W_y$	$\Phi = 0$	0.298	0.328	0.358	--	
Viewing Angle	$\phi = 180^\circ$	$\theta_l$	$CR \geq 10$	65	70	--	Degree	1
	$\phi = 0^\circ$	$\theta_r$		65	70	--		
	$\phi = 90^\circ$	$\theta_u$	65	55	60	--		
	$\phi = 270^\circ$	$\theta_d$		55	60	--		
Brightness	--	--	300	350	--	cd/m <sup>2</sup>	Center of display	

Note1: Definition of viewing angle range

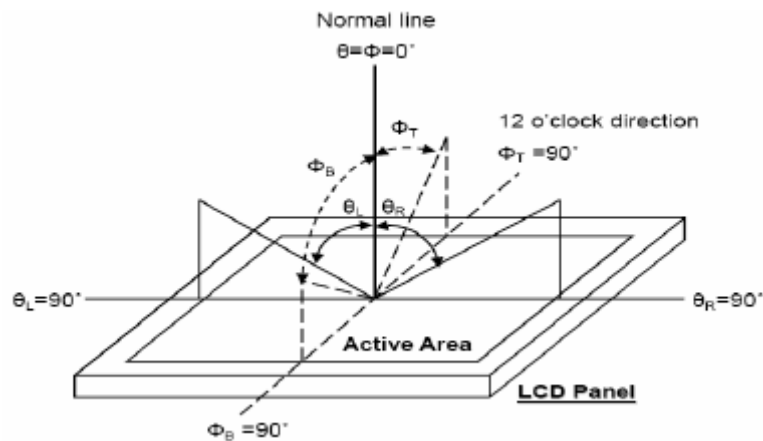

6 o'clock direction  
Fig. 7-1 Definition of viewing angle



Microtips Technology Inc.

Messrs.					
Product Specification	Model:	MTF-TW70SN911-LB	Rev. No.	Issued Date.	Page.
			A	May.07, 09	7 / 23

**Note 2: Test equipment setup:**

After stabilizing and leaving the panel alone at a driven temperature for 10 minutes, the Measurement should be executed. Measurement should be executed in a stable, windless, and dark room. Optical specifications are measured by Topcon BM-7 Luminance meter 1.0° field of View at a distance of 50cm and normal direction.

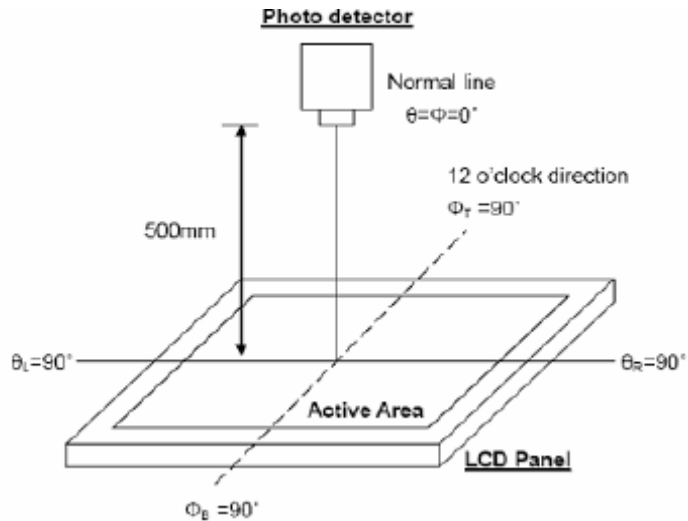

**6 o'clock direction**  
**Fig. 7-2 Optical measurement system setup**

**Note 3: Definition of Response time:**

The response time is defined as the LCD optical switching time interval between “White state and “Black” state. Rise time,  $T_r$ , is the time between photo detector output intensity changed from 90% to 10%. And fall time,  $T_f$ , is the time between photo detector output Intensity changed from 10% to 90%.

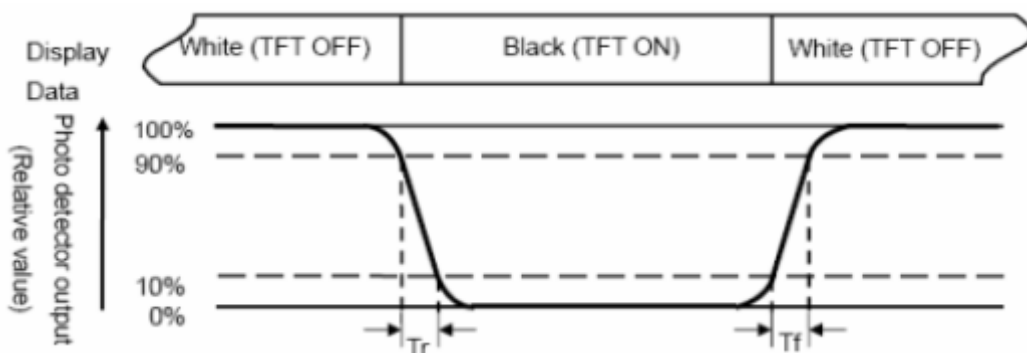

**Fig. 3-3 Definition of response time**



Messrs.					
Product Specification	Model:	MTF-TW70SN911-LB	Rev. No.	Issued Date.	Page.
			A	May.07, 09	8 / 23

Note 4: Definition of contrast ratio:

The contrast ratio is defined as the following expression:

$$\text{Contrast Ratio (CR)} = \frac{\text{Luminance measured when LCD on the "White" state}}{\text{Luminance measured when LCD on the "Black" state}}$$

Note 5: White  $V_i = V_{i50} \pm 1.5V$     Black  $V_i = V_{i50} \pm 20V$

“±” Means that the analog input swings in phase with VCOM signal.

“±” Means that the analog input swings out of phase with VCOM signal.

The 100% transmission is defined as the transmission of LCD panel when all the input Terminals of module are electrically opened.

Note 6: Definition of color chromaticity (CIE 1931)

Color coordinates measured at the center point of LCD

Note 7: Measured at the center area of the panel when all the input terminals of LCD panel are electrically opened.

$$\text{Note 8: Uniformity (U)} = \frac{\text{Brightness ( min )}}{\text{Brightness ( max )}} \times 100\%$$



*Microtips Technology Inc.*



Messrs.					
Product Specification	Model:	MTF-TW70SN911-LB	Rev. No.	Issued Date.	Page.
			A	May.07, 09	9 / 23

### 3.2 LED Driving Conditions

Parameter	Symbol	Min	Typ	Max	Unit	Note
LED current	$I_{LED}$	--	160	--	mA	1
LED voltage	$V_{LED}$	--	9.9	--	V	--
LED Life Time	--	10,000	20,000	--	Hr	2

Note1: There are 8 Groups LED shown as below,  $V_{LED} = 9.9V$ ,  $I_{LED} = 160mA$

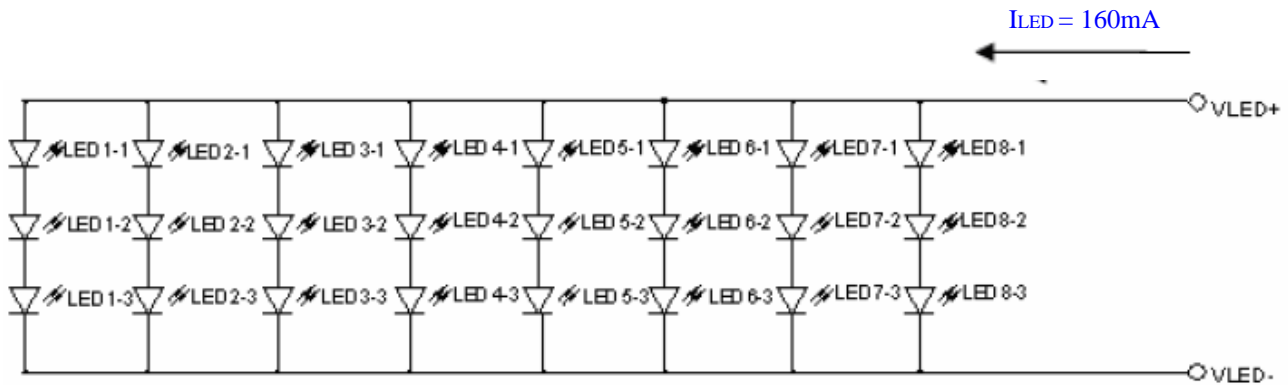

Note2: Brightness to be decreased to 50% of the initial value.



Messrs.					
Product Specification	Model:	MTF-TW70SN911-LB	Rev. No.	Issued Date.	Page.
			A	May.07, 09	10 / 23

#### 4. INPUT SIGNAL (DE ONLY MODE)

##### 4.1 Timing Specification

Parameter	Symbol	Min	Typ	Max	Unit
Data Setup Time	Tdsu	6	--	--	ns
Data Hold Time	Tdhd	6	--	--	T <sub>CPH</sub>
DE Setup Time	Tesu	6	--	--	
CLK Frequency	F <sub>CPH</sub>	--	33.26	--	MHz
CLK Period	T <sub>CPH</sub>	20	30.06	50	ns
CLK Pulse Duty	T <sub>CWH</sub>	40	50	60	%
DE Period	T <sub>DEH</sub> + T <sub>DEL</sub>	1000	1056	1200	T <sub>CPH</sub>
DE Pulse Width	T <sub>DEH</sub>	--	800	--	
DE Frame Blanking	T <sub>DEB</sub>	10	45	110	T <sub>DEH</sub> + T <sub>DEL</sub>
DE Frame Width	T <sub>DE</sub>	--	480	--	



Messrs.					
Product Specification	Model:	MTF-TW70SN911-LB	Rev. No.	Issued Date.	Page.
			A	May.07, 09	11 / 23

#### 4.2 Timing Controller Timing Chart

Clock and Data input waveforms

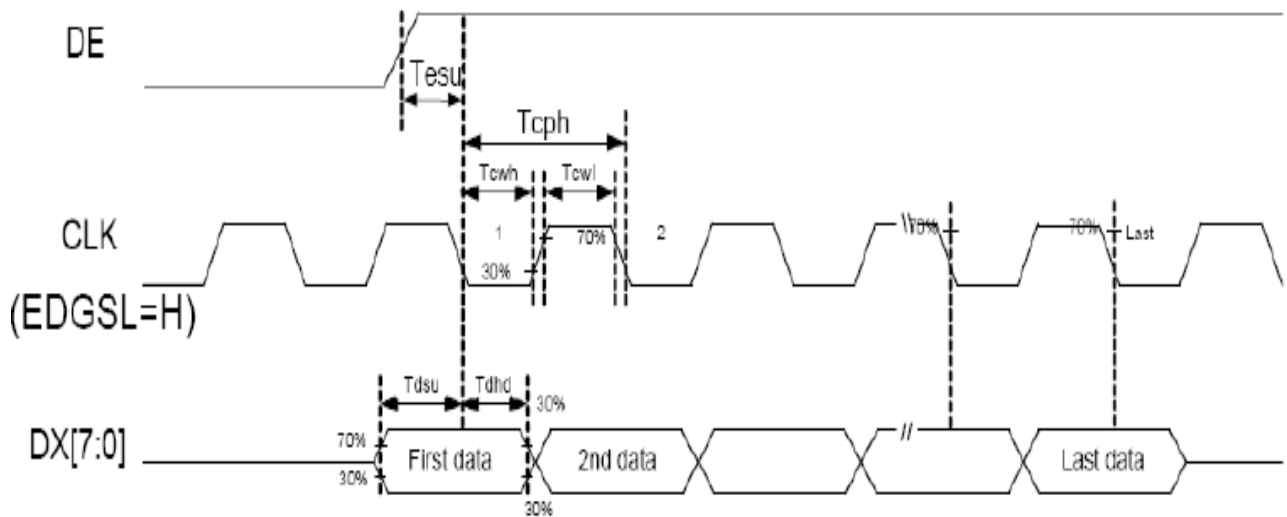
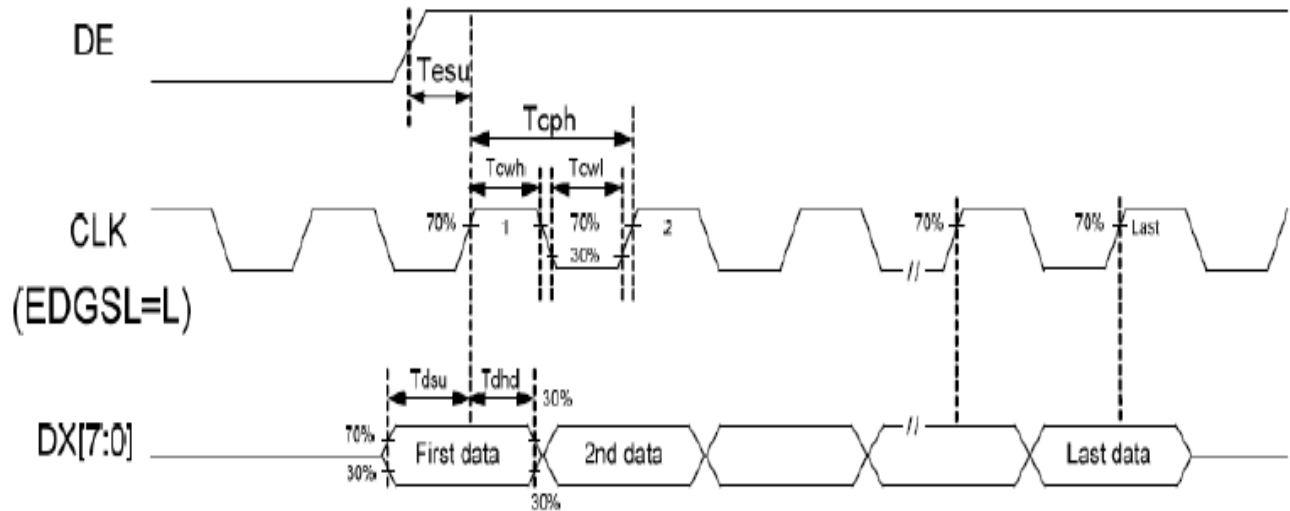

Messrs.					
Product Specification	Model:	MTF-TW70SN911-LB	Rev. No.	Issued Date.	Page.
			A	May.07, 09	12 / 23

4.2.1 Data input format

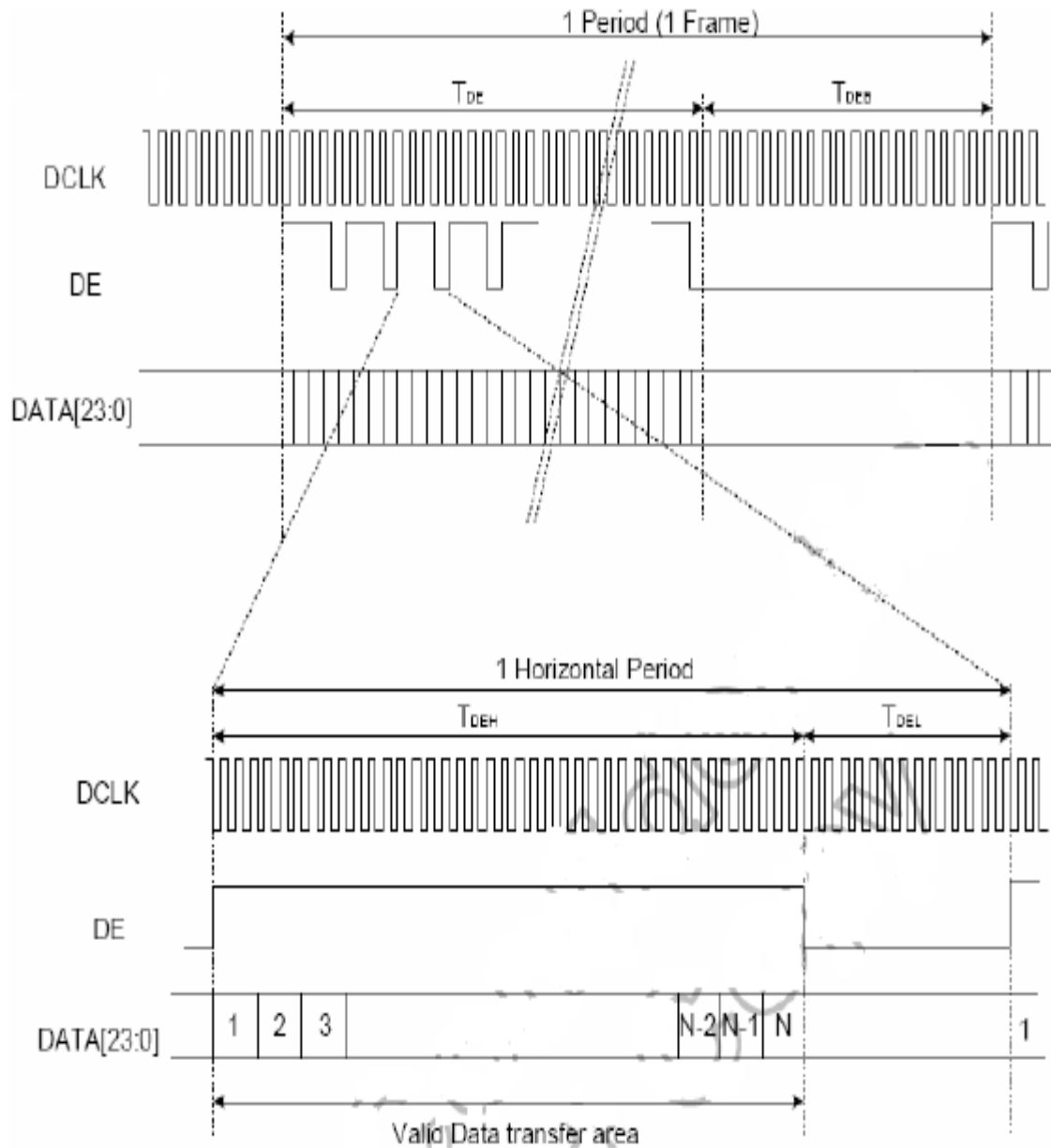

Messrs.					
Product Specification	Model:	MTF-TW70SN911-LB	Rev. No.	Issued Date.	Page.
			A	May.07, 09	13 / 23

#### 4.2.2 Power ON/OFF sequence

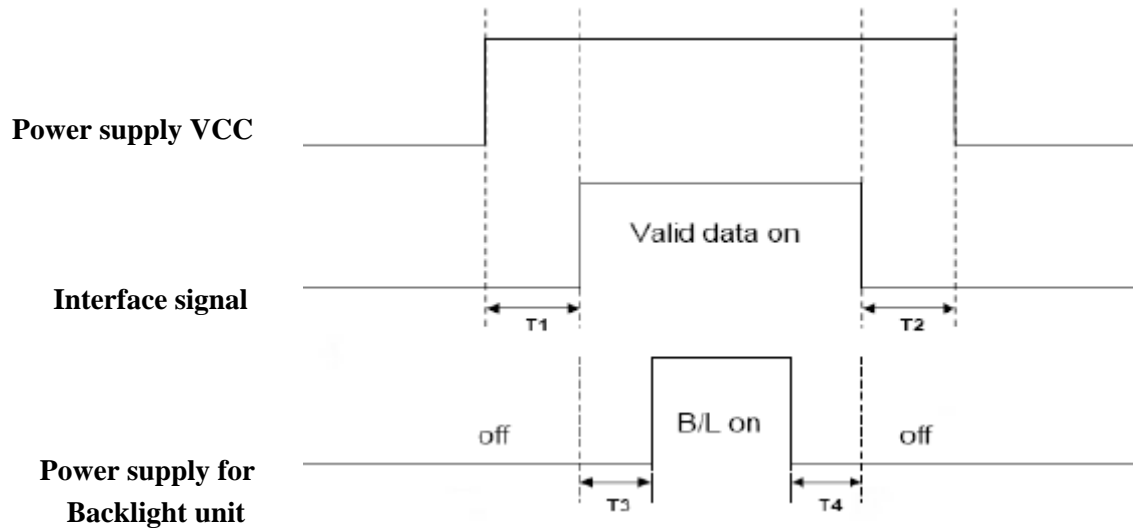

Parameter	Spec			Unit
	Min	Typ	Max	
T1	0	--	60	mS
T2	0	--	60	mS
T3	200	--	--	mS
T4	200	--		mS



Messrs.					
Product Specification	Model:	MTF-TW70SN911-LB	Rev. No.	Issued Date.	Page.
			A	May.07, 09	14 / 23

## 5. PIN ASSIGNMENT

### 5.1 LCM Pin Definition

Pin No.	Symbol	I/O	Function	Remark
1	GND	--	Power Ground	--
2	GND	--	Power Ground	--
3	Reserve	--	For internal Testing	--
4	Reserve	--	For internal Testing	--
5	Reserve	--	For internal Testing	--
6	Reserve	--	For internal Testing	--
7	V <sub>CC</sub>	--	Power Supply for Digital Circuit	--
8	V <sub>CC</sub>	--	Power Supply for Digital Circuit	--
9	DE	--	Data Enable	--
10	GND	--	Power Ground	--
11	GND	--	Power Ground	--
12	GND	--	Power Ground	--
13	B5	I	Blue Data 5 (MSB)	--
14	B4	I	Blue Data 4	--
15	B3	I	Blue Data 3	--
16	GND	--	Power Ground	--
17	B2	I	Blue Data 2	--
18	B1	I	Blue Data 1	--
19	B0	I	Blue Data 0 (LSB)	--
20	GND	--	Power Ground	--
21	G5	I	Green Data 5 (MSB)	--
22	G4	I	Green Data 4	--
23	G3	I	Green Data 3	--
24	GND	--	Power Ground	--
25	G2	I	Green Data 2	--
26	G1	I	Green Data 1	--
27	G0	I	Green Data 0 (LSB)	--
28	GND	--	Power Ground	--
29	R5	I	Red Data 5 (MSB)	--
30	R4	I	Red Data 4	--
31	R3	I	Red Data 3	--
32	GND	--	Power Ground	--
33	R2	I	Red Data 2	--
34	R1	I	Red Data 1	--
35	R0	I	Red Data 0 (LSB)	--
36	GND	--	Power Ground	--
37	GND	--	Power Ground	--
38	DCLK	I	Clock Signals; Latch Data at the Falling Edge	--
39	GND	--	Power Ground	--
40	GND	--	Power Ground	--



Messrs.					
Product Specification	Model:	MTF-TW70SN911-LB	Rev. No.	Issued Date.	Page.
			A	May.07, 09	15 / 23

## 5.2 Backlight Driving Part

Pin No.	Symbol	I/O	Function	Remark
1	VLED+	--	Red , LED__Anode	--
2	VLEDD-	--	White , LED__Cathode	--

Note: The backlight interface connector is a model **SM02B-BHSS-1-TB** manufactured by JST or equivalent. The matching connector part number is **BHSR-20VS-1** manufactured by JST or equivalent.



Messrs.					
Product Specification	Model:	MTF-TW70SN911-LB	Rev. No.	Issued Date.	Page.
			A	May.07, 09	16 / 23

## 6. BLOCK DIAGRAM

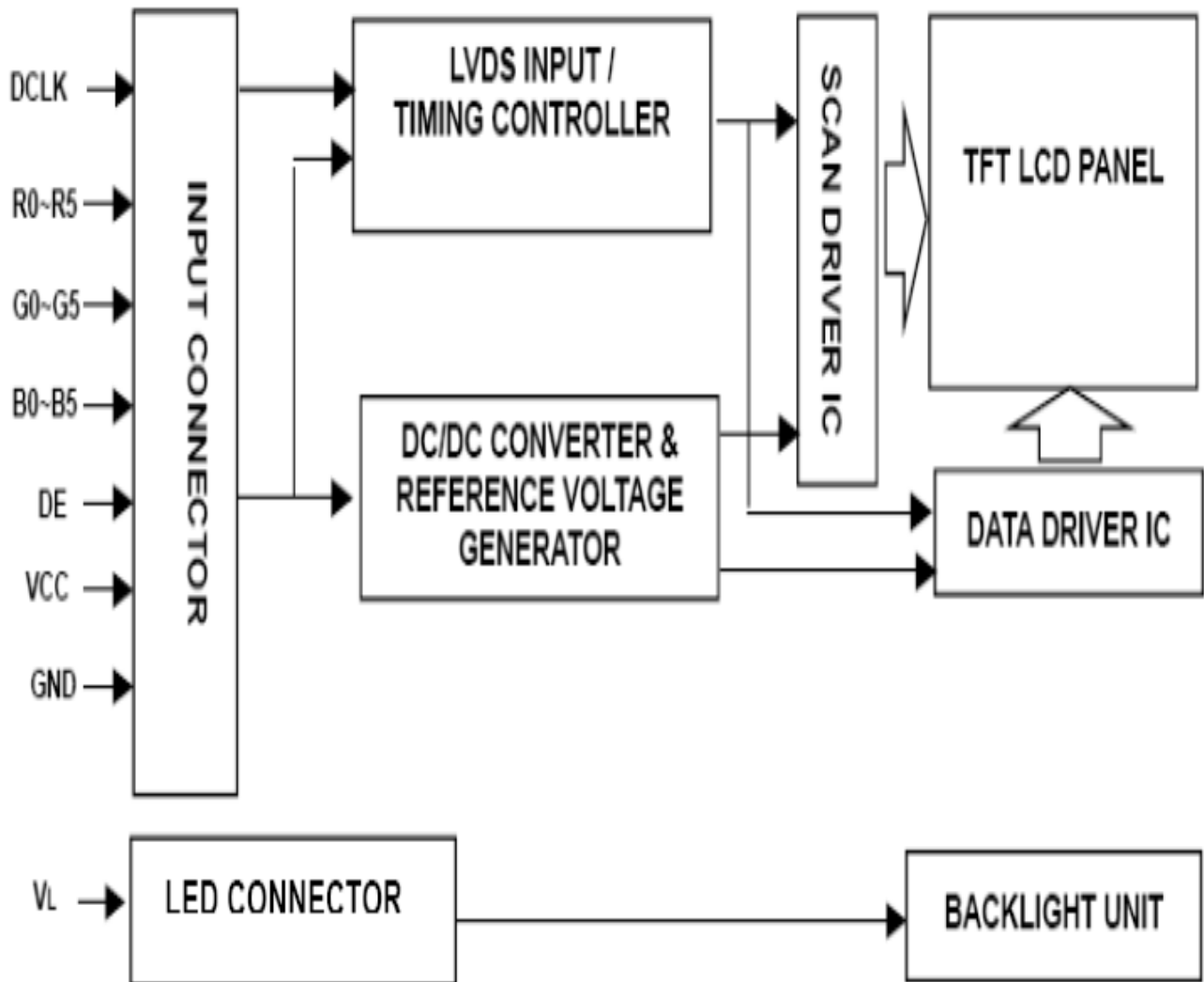



Messrs.					
Product Specification	Model:	MTF-TW70SN911-LB	Rev. No.	Issued Date.	Page.
			A	May.07, 09	17 / 23

## 7. DISPLAYED COLOR AND INPUT DATA

	Color & Gray Scale	Data Signal																	
		R5	R4	R3	R2	R1	R0	G5	G4	G3	G2	G1	G0	B5	B4	B3	B2	B1	B0
Basic Color	Black	0	0	0	0	0	0	0	0	0	0	0	0	0	0	0	0	0	0
	Red(0)	1	1	1	1	1	1	0	0	0	0	0	0	0	0	0	0	0	0
	Green(0)	0	0	0	0	0	0	1	1	1	1	1	1	0	0	0	0	0	0
	Blue(0)	0	0	0	0	0	0	0	0	0	0	0	0	1	1	1	1	1	1
	Cyan	0	0	0	0	0	0	1	1	1	1	1	1	1	1	1	1	1	1
	Magenta	1	1	1	1	1	1	0	0	0	0	0	0	1	1	1	1	1	1
	Yellow	1	1	1	1	1	1	1	1	1	1	1	1	0	0	0	0	0	0
	White	1	1	1	1	1	1	1	1	1	1	1	1	1	1	1	1	1	1
Red	Black	0	0	0	0	0	0	0	0	0	0	0	0	0	0	0	0	0	0
	Red(62)	0	0	0	0	0	1	0	0	0	0	0	0	0	0	0	0	0	0
	Red(61)	0	0	0	0	1	0	0	0	0	0	0	0	0	0	0	0	0	0
	:	:	:	:	:	:	:	:	:	:	:	:	:	:	:	:	:	:	:
	Red(31)	0	1	1	1	1	1	0	0	0	0	0	0	0	0	0	0	0	0
	:	:	:	:	:	:	:	:	:	:	:	:	:	:	:	:	:	:	:
	Red(1)	1	1	1	1	1	0	0	0	0	0	0	0	0	0	0	0	0	0
	Red(0)	1	1	1	1	1	1	0	0	0	0	0	0	0	0	0	0	0	0
Green	Black	0	0	0	0	0	0	0	0	0	0	0	0	0	0	0	0	0	0
	Green(62)	0	0	0	0	0	0	0	0	0	0	0	1	0	0	0	0	0	0
	Green(61)	0	0	0	0	0	0	0	0	0	0	1	0	0	0	0	0	0	0
	:	:	:	:	:	:	:	:	:	:	:	:	:	:	:	:	:	:	:
	Green(31)	0	0	0	0	0	0	0	1	1	1	1	0	0	0	0	0	0	0
	:	:	:	:	:	:	:	:	:	:	:	:	:	:	:	:	:	:	:
	Green(1)	0	0	0	0	0	0	1	1	1	1	1	0	0	0	0	0	0	0
	Green(0)	0	0	0	0	0	0	1	1	1	1	1	1	0	0	0	0	0	0
Blue	Black	0	0	0	0	0	0	0	0	0	0	0	0	0	0	0	0	0	0
	Blue(62)	0	0	0	0	0	0	0	0	0	0	0	0	0	0	0	0	0	1
	Blue(61)	0	0	0	0	0	0	0	0	0	0	0	0	0	0	0	0	1	0
	:	:	:	:	:	:	:	:	:	:	:	:	:	:	:	:	:	:	:
	Blue(31)	0	0	0	0	0	0	0	0	0	0	0	0	0	1	1	1	1	1
	:	:	:	:	:	:	:	:	:	:	:	:	:	:	:	:	:	:	:
	Blue(1)	0	0	0	0	0	0	0	0	0	0	0	0	1	1	1	1	1	0
	Blue(0)	0	0	0	0	0	0	0	0	0	0	0	0	1	1	1	1	1	1

0: Low level voltage, 1: High level voltage

Each basic color can be displayed in 64 gray scales from 6 bit data signals. With the combination of total 18 bit data signals, the 262,144-color display can be achieved on the screen.



*Microtips Technology Inc.*

Messrs.					
Product Specification	Model:	MTF-TW70SN911-LB	Rev. No.	Issued Date.	Page.
			A	May.07, 09	18 / 23

## 8. RELIABILITY CONDITION

### 8.1 Test Item

No change on display and in operation under the following test condition.

Condition: Unless otherwise specified, tests will be conducted under the following condition.

Temperature: 20±25°C

Humidity: 65±5%RH

Tests will be not conducted under functioning state.

No.	Parameter	Condition	Notes
1	High Temperature Storage Test	Ta= 80°C Dry 240 Hrs	--
2	Low Temperature Storage Test	Ta= -30°C Dry 240 Hrs	--
3	High Temperature Operation Test	Ta= 70°C Dry 240 Hrs	--
4	Low Temperature Operation Test	Ta= -20°C Dry 240 Hrs	--
5	High Temperature and High Humidity Operation Test	Ta = 60°C 90%RH 240 Hrs	--
6	Electro Static Discharge Test	150pF , 330Ω, ±8KV(Contact)/±15KV(Air), 5points/panel, 5times/point	--
7	Shock Test (non-operating)	Half sine wave, 180G, 2ms one Shock of each six faces ( I.e. run 180G, 2ms for all six faces)	--
8	Vibration Test (non-operating)	Sine wave, 10 ~ 500 ~ 10Hz , 1.5G, 0.37oct/min 3axis, 1hour/axis	--
9	Thermal Shock Test	-20°C(0.5h) ~ 70°C(0.5h ) / 100 cycles(Dry)	--

\*\*\*\*\* Ta = Ambient Temperature



*Microtips Technology Inc.*

Messrs.					
Product Specification	Model:	MTF-TW70SN911-LB	Rev. No.	Issued Date.	Page.
			A	May.07, 09	19 / 23

## 9. PRECAUTIONS





### 9.1 Operation

Burn-in sometimes happens when the same character was displayed at along time. Therefore, to prevent Burn-in, it is recommended to set up a Screen-saver function.

### 9.2 Safety

The liquid crystal in the LCD is poisonous, DO NOT put it in your mouth. If the liquid crystal touches your skin or clothes, wash it off immediately using soap and water.







### 9.3 Handling

	<p>a. The LCD module shall be installed flat, without twisting or bending.</p> <p>b. COF or FPC has narrow pattern width, so easily become open circuit by external force. DO NOT apply pressure to COF or FPC especially in bending area.</p>
	<p>c. To avoid damage in appearance or malfunction, DO NOT subject the module to mechanical shock or to excessive force on its surface.</p>
	<p>d. The polarizer attached to the display is very easy to damage, handle it with care to avoid scratching.</p>
	<p>e. To avoid contamination on the display surface, DO NOT touch the display surface with bare hands.</p> <p>f. Provide a space so that the LCD module does not come into contact with other components.</p>

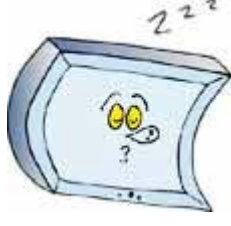

Messrs.

Product Specification	Model:	MTF-TW70SN911-LB	Rev. No.	Issued Date.	Page.
			A	May.07, 09	20 / 23

	<p>g. To protect the LCD panel from external pressure, put covering glass (acrylic board or similar board) to keep appropriate space between them.</p>
	<p>h. Be careful for condensation at sudden temperature change. Condensation makes damage to polarizer or electrical contacted parts. And after fading condensation, smear or spot will occur.</p>
	<p>i. Property of semiconductor devices may be affected when they are exposed to light possibly resulting in malfunctioning of the ICs. To prevent such malfunctioning of the ICs, your design and mounting layout done are so that the IC is not exposed to light in actual use.</p>
	<p>j. Strong light exposure causes degradation of color filter. It may not recover</p>
	<p>k. DO NOT contact with water to avoid Metal corrosion.</p> <p>l. When it is not in use, the screen must be turned off or the pattern must be frequently changed by a screen saver. If it displays the same pattern for a long period of time, brightness down/image sticking may develop due to the LCD structure.</p>
	<p>m. Never disassemble LCD product under any circumstances. If unqualified operators or users assemble the product after disassembling it, it may not function or its operation may be seriously affected.</p>



*Microtips Technology Inc.*

Messrs.					
Product Specification	Model:	MTF-TW70SN911-LB	Rev. No.	Issued Date.	Page.
			A	May.07, 09	21 / 23

#### 9.4 Static electricity

Since a module is composed of electronic circuits, it is not strong to electrostatic discharge.

	<ol style="list-style-type: none"> <li>The LCD module shall be installed flat, without twisting or bending. Ground soldering iron tips, tools and testers when they operate.</li> <li>Ground your body when handling the products.</li> <li>DO NOT apply voltage to the input terminal without applying power supply.</li> <li>DO NOT apply voltage that exceeds the absolute maximum rating.</li> <li>Store the products in an anti-electrostatic container.</li> <li>Peel off protect tape, attached to polarizer, slowly to minimize ESD damage.</li> </ol>
---	--

#### 9.5 Storage

	<p>Store the products in a dark place at +5 ~ +25 degree C, low humidity (50%RH or less). DO NOT store the products in an atmosphere containing organic solvents or corrosive gases.</p>
---	--

#### 9.6 Cleaning

	<ol style="list-style-type: none"> <li>DO NOT wipe the polarizer with dry cloth, as it might cause scratch.</li> <li>Wipe the polarizer with a soft cloth soaked with petroleum IPA, other chemical might damage.</li> </ol>
---	--

#### 9.7 Waste

	<p>When dispose of LCD module, manage it at the production waste according to the relevant laws and regulations.</p>
---	--



Messrs.					
Product Specification	Model:	MTF-TW70SN911-LB	Rev. No.	Issued Date.	Page.
			A	May.07, 09	22 / 23

## 10. WARRANTY

This product has been manufactured to your company's specifications as a part for use in your company's general electronic products. It is guaranteed to perform according to delivery specifications. For any other use apart from general electronic equipment, we cannot take responsibility if the product is used in medical devices, nuclear power control equipment, aerospace equipment, fire and security systems, or any other applications in which there is a direct risk to human life and where extremely high levels of reliability are required. If the product is to be used in any of the above applications, we will need to enter into a separate product liability agreement.

- 1 13 months guarantee starts from the date code.
- 2 We cannot accept responsibility for any defect, which may arise from additional manufacturing of the product (including disassembly and reassembly), after product delivery.
- 3 We cannot accept responsibility for any defect, which may arise after the application of strong external force to the product.
- 4 We cannot accept responsibility for any defect, which may arise due to the application of static electricity after the product has passed your company's acceptance inspection procedures.
- 5 We cannot accept responsibility for industrial property, which may arise through the use of your product, with exception to those issues relating directly to the structure or method of manufacturing of our product. Microtips-origin longer than one year from Microtips production.

## 11. DIMENSIONAL OUTLINES

- See the next page.....



*Microtips Technology Inc.*

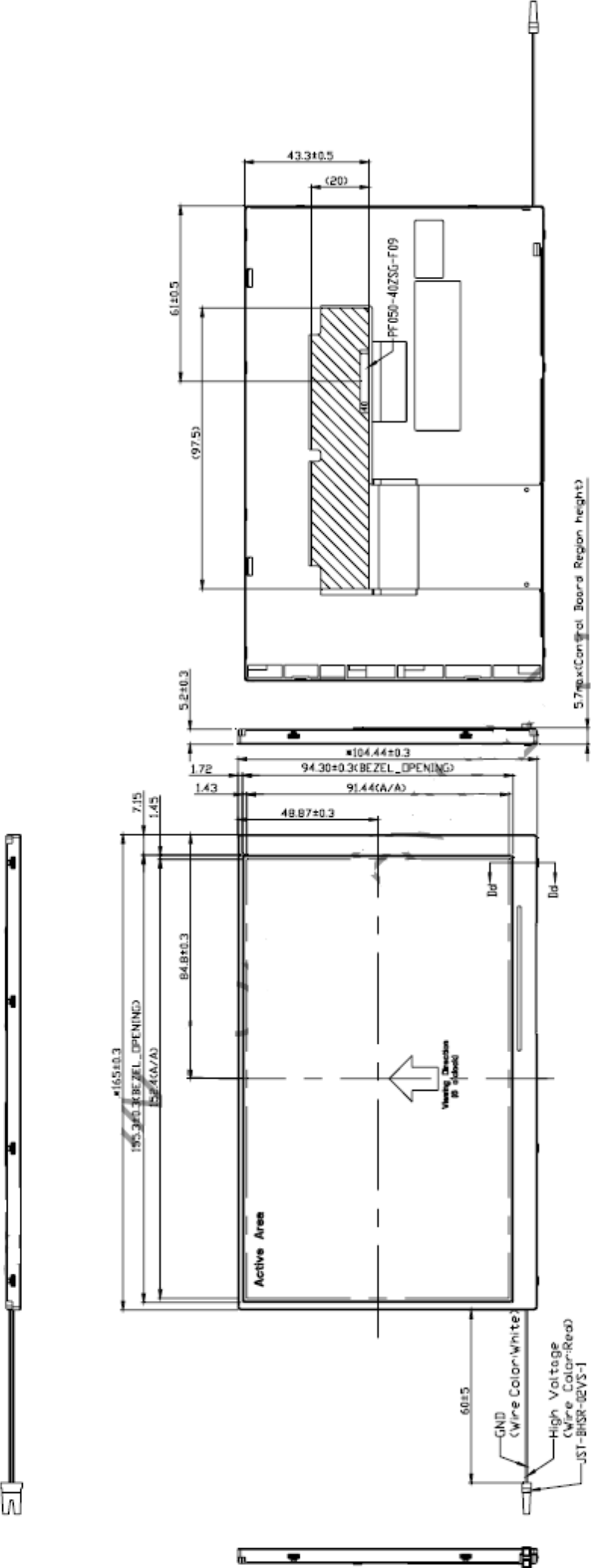

Recommended FPC Outline Dimension  
 (Suitable connector: PF050-40ZSG-F09  
 made by LUU Electronics or equivalent)

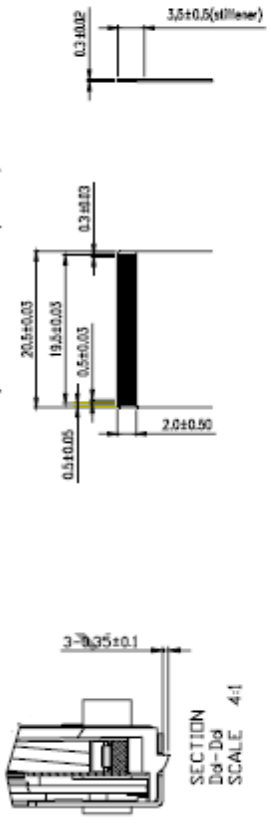

Note:  
 1. Important Dimension.  
 2. General Tolerance:  $\pm 0.3$ mm.

REV	NO.	DATE

▨ component area

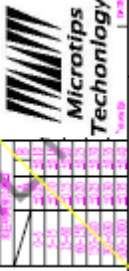

MTF-TW70SN911-1.B

DATE	NO.	DATE	NO.